

Voltas Customer Care Life Cycle Support

Through **MANAGED Services**

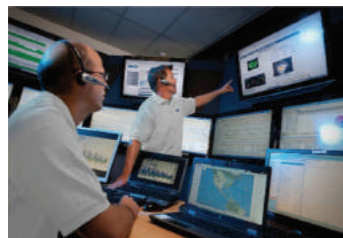

Remote Monitoring



Digital Service Reports



24x7 Helpdesk

**Voltas is 'Grade 1'
Energy Service Company (ESCO)**

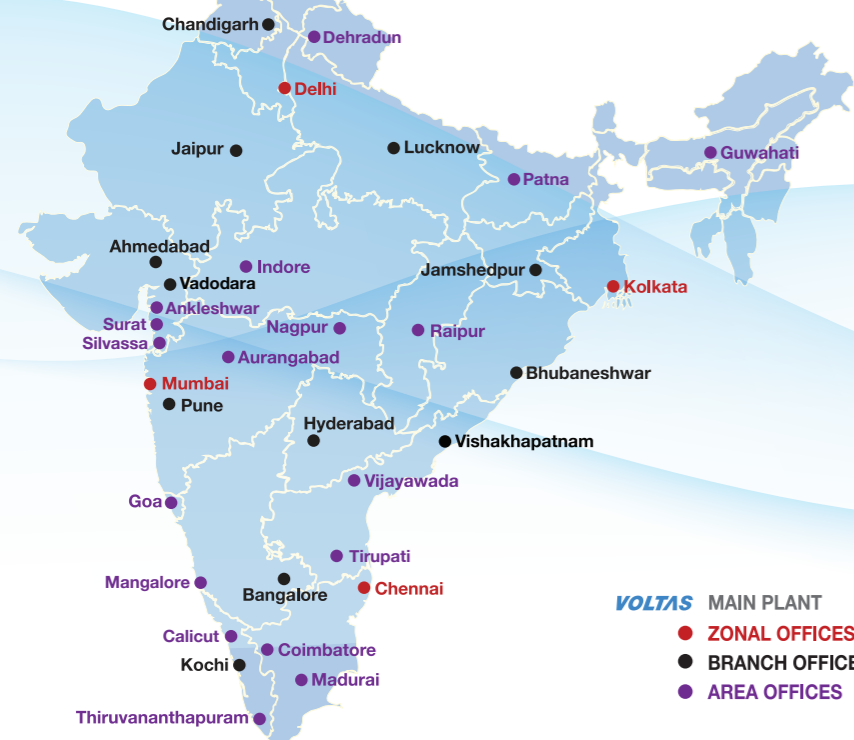

Voltas National Network
Easy Access • Quick Satisfaction

Customer Care
9100660100

MEP Services :

- Electro-mechanical Services
- HVAC
- Refrigeration

Water and Wastewater Management

Value Added Services

Follow us at : [f My Voltas](#) [t My Voltas](#) [i My Voltas](#) [in Voltas Limited](#) [v My Voltas](#)



VOLTAS LIMITED
Domestic Projects Group, Voltas House 'B', 3rd floor, T. B. Kadam Marg, Chinchpokli, Mumbai-400 033, India
Tel: +91 22 6665 6857. Email: bijogeorge@voltas.com, jatinpanchal@voltas.com, shubhambahadkar@voltas.com,
North: psnorth@voltas.com, East: pseast@voltas.com, South: psouth@voltas.com, West: pswest@voltas.com
Website: www.voltas.com

NORTH ZONE: DELHI (011) 66505659/66505678/66505680/66505657 CHANDIGARH (0172) 4111800 JAIPUR (0141) 6541011 LUCKNOW 8840739788
EAST ZONE: KOLKATA (033) 66266268 / 662662283 / 66266262 BHUBANESHWAR (0674) 2747868 PATNA (0612) 2500786 RAIPUR (077) 14033886
WEST ZONE: MUMBAI (022) 66656754/ 66656756 / 66656757 / 66656759 / 66656760 NAGPUR (0712) 6456894 AHMEDABAD (079) 66301102 / 6630 1107 PUNE (020) 66297446 INDORE (0731) 2498616 **SOUTH ZONE:** CHENNAI (044) 66762357 / 66760346 / 66760355 BENGALURU (080) 22535648
HYDERABAD (040) 66743007 COCHIN (0484) 6605527.

VLVRF/INV/07/2020

India's Largest Air Conditioning Company



Voltas VXV GEN6 VRF series

VXV 6 Series
ALL DC Inverter

with **VEER** Technology



Outdoor Units - Upto 88 HP

Profile

Voltas, a member of the Tata Group, is India's No.1 air conditioning company and one of the world's premier engineering solutions providers and project specialists.

Founded in India in 1954, Voltas Limited offers premier cooling and engineering solutions for a wide spectrum of industries in areas such as heating, ventilation and air conditioning, refrigeration, electro-mechanical projects, textile machinery, mining and construction equipment, water management & treatment, cold chain solutions, building management systems, electrification and indoor air quality.

The Company's strengths lies principally in:

- Management and execution of electro-mechanical projects, Including air conditioning and refrigeration.
- Sourcing, installation and servicing of diverse technology-based systems serving Indian industries through representation of global technology leaders.

Organization

Voltas' operations have been organized into three independent business-specific clusters. Each of these has its own facilities for market coverage and service to customers.

Unitary Cooling Products

- ★ Air Conditioners
- ★ Commercial Refrigeration
- ★ Water Coolers & Dispensers

Domestic Projects Group

- ★ Electrical, Mechanical & Refrigeration Solutions
- ★ Electrical & Mechanical Solutions (international)
- ★ Electrical Projects Business - focusing on Rural
- ★ Electrification (Distribution / Improvement)
- ★ Water Management Business Division - Large Capacity STP (MLD), Effluent treatment, Rural Water Supply Scheme.
- ★ Customer Care - Life Cycle Management through managed services

Engineering Products and Services

- ★ Textile Machinery
- ★ Mining & Construction Equipment

Awards & Recognition

2018

- ★ Voltas "India's Most Trusted Air Conditioner Brand"
- ★ Strategy Leaders Summit & Awards 2018.
- ★ MEP Contractor and Plumbing Project of the Year award.

2017

- ★ **Indywood Built in India Excellence award**
- ★ **IGBC** - 'Gold' rating for Voltas Limited Office at Coimbatore.

2016

- ★ **Winner of Eco Times'** Best Corporate Brands 2016

2015

- ★ **Dun & Bradstreet Corporate Awards**
- ★ **Top Taxpayers' Award** Dept. of Central Excise & Service Tax
- ★ **EFFIE Award (silver)** for Effectiveness in Advertising

2014

- ★ **Tata Group's Excellence in Communications Award**
- ★ **World Advertising Research Centre** Asia Awards Gold Prize
- ★ **National Energy Conservation Award** Govt. of India Ministry of Power



Voltas was recognised as the 'Best Brand in Digital Marketing Excellence in Consumer Durables Category' at DigiXX 2018



Voltas Domestic Projects Group recognized at **Indywood Built In India Excellence Awards 2018**

2008 / 2010 / 2011 / 2012 / 2013

- ★ **MEP Middle East Awards**
- ★ **MEP Contractor of the Year**
- ★ **MEP Project Manager of the Year' and 'Health & Safety'.**
- ★ **Silver LEED certification**
- ★ **Bry-Air Award for excellence in product Design for VAM**

Product Lineup

Modular VRF Outdoor Unit (All DC Inverter)

Capacity	(kW)	25.2	28.0	33.5	40.0	45.0	50.4	56.0	61.5
	(HP)	8	10	12	14	16	18	20	22

VXV 6



Top Discharge Modular

●	●	●	●	●	●	●	●	●	●
---	---	---	---	---	---	---	---	---	---

Individual VRF Outdoor Unit

Capacity	(kW)	61.5	67.0	73.0	78.5	85.0	90.0
	(HP)	22	24	26	28	30	32

VXV Individual Series

Top Discharge Non-Modular

●	●	●	●	●	●	●	●
---	---	---	---	---	---	---	---

Mini VRF Outdoor Unit

Capacity(kW)	Appearance	8	10	12	14	16	22	28
--------------	------------	---	----	----	----	----	----	----

VXV Mini

Side Discharge



●	●	●	●	●	●	●	●	●
---	---	---	---	---	---	---	---	---

Indoor Unit

Capacity(kW)	Appearance	2.2	2.8	3.6	4.5	5.6	7.1	8.0	9.0	10.0	11.2	12.5	14.0	15.0
One-way Cassette		●	●	●	●	●	●							
Two-way Cassette		●	●	●	●	●	●							
Four-way Cassette			●	●	●	●	●	●	●	●	●	●	●	●
Slim Duct		●	●	●	●	●	●							
Mid ESP Duct					●	●	●	●	●	●	●	●	●	●
High ESP Duct											●	●	●	●
Ceiling&Floor					●	●	●	●	●	●	●	●	●	●
Wall-mounted		●	●	●	●	●	●							

Capacity(kW)	Appearance	19.3	22.0	28.0	30.0	39.0	45.0	56.0
--------------	------------	------	------	------	------	------	------	------

High ESP Duct



●	●	●	●	●	●	●	●
---	---	---	---	---	---	---	---

VXV 6 Series

Voltas presents latest 6th Generation VRF with All DC Inverter, VEER Technology and various features like...

VEER Technology

Evaporating and condensing temperature makes strong effect to the cooling and heating performance and energy-efficiency ratio of AC system. Thanks to Variable Energy-Efficiency Regulation Technology, VXV6 series has various modes with different refrigerant temperature which lead the system to different performance and energy-efficiency ratio.

High EER and COP

VXV 6 series achieves industry highest efficiency in cooling and heating by utilizing all DC inverter compressors. The cooling EER is upto 4.75 and heating COP is 5.48 for 8 HP model

Wide Operation Range

VXV 6 has wide operating range from -15°C to 52°C. It doesn't matter whether it's as hot as 52°C or as low as -15°C outside, the system shall supply comfortable environment for occupants.

Fast Warm Up and Cool Down

The DC Inverter Compressor system reaches full load rapidly providing less temperature fluctuation and an improved living environment, bring great user experience.



DC Brushless Fan Motor

DC brushless motor adjusts the fan speed according to the system pressure, and running load to enhance the efficiency by 45%. The super aero fan provides a larger air volume and higher static pressure.

High efficiency heat - exchanger

Optimized 2 to 1 refrigerant circuit design, increase the heat exchanging efficiency and enhance the ratio of liquid which flow to the evaporator.

Precise Temperature Control

VOLTAS composite temperature control technology, through the indoor/outdoor operation condition detection, adjusts outdoor power output, optimize the indoor air distribution, achieve the high precision adjustment of 0.5.

Refrigerant PCB Cooling System

The PCB is well cooled by the refrigerant, ensuring the system operate steadily even in hot area.

DLF - Belaire, Gurgaon

Mindtree, Hyderabad

Ackruti VIVA, Mumbai



Features

Variable Energy-Efficiency Regulation -VEER Technology

Evaporating and condensing temperature makes strong effect to the cooling and heating performance and energy-efficiency ratio of AC system.

Thanks to VEER technology, VXV 6 Series has various modes with different refrigerant temperature which lead the system to different performance and energy-efficiency ratio.

Cooling: 3 modes with different evaporating temperature.

Heating: 3 modes with different condensing temperature.

Turbo mode

High cooling and heating performance, cool down or warm up the room rapidly.

Basic mode

Default mode, balance the reaction speed and efficiency.

High efficiency mode

Satisfy the lowest capacity requirement and low the energy consumption.

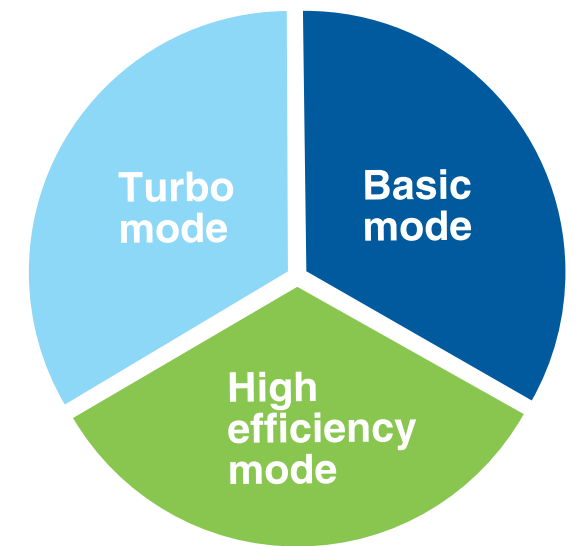

Users can choose a certain mode according to the actual need in different area and climate, so that the system can satisfy various requirement, and the seasonal efficiency can be optimized.

Long Piping Length

Thanks to the DC inverter control technology and sub-cooling circuit technology, it is possible to design a system with longer piping and elevation difference which make it easier to design and installation.

Max. Total piping length — 1000m

Max. Actual piping length — 240m

Max. piping length from 1st indoor branch to the farthest indoor unit — 40m/90m*

Max. Level difference between outdoor units — 5m

Max. Level difference between indoor units — 30m

Max. Level difference between ODU and IDU units — 110m

*The longest length after first branch is 40m as standard can be extended to up to 90m under certain conditions. Please contact your local dealer for further information.

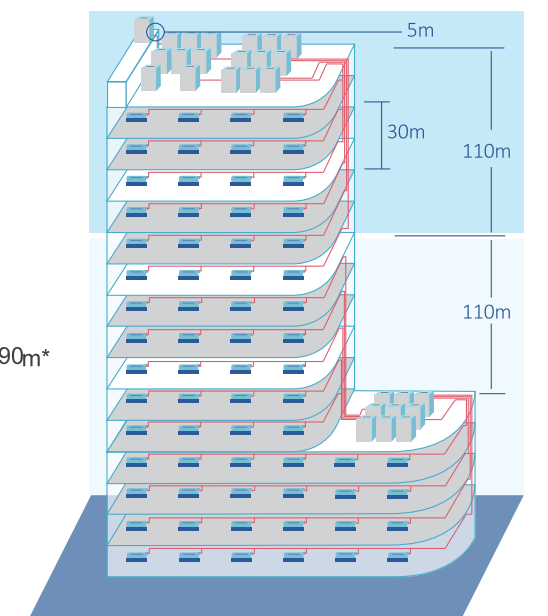

Features

DC Inverter Compressor

Optimize the asymmetric vortex design

Heating condition, reducing the outlet temperature, increasing the compressor capacity, improving the heating performance.

Dynamic oil balance structure

Oil balance tube implementation parallel compressor and oil quantity dynamic equilibrium, ensuring the reliability of several paralleled compressors.

High efficiency motor configuration

Using high quality material concentrated stator, cooperate with neodymium magnet rotor, having outstanding efficiency.

High pressure cavity structure

Large exhaust buffer volume, reducing the air flow noise and vibration of the runtime.

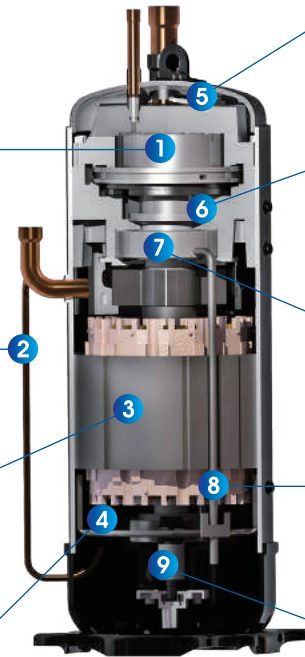

Pressure relief valve structure

Improving the partial load efficiency, adapt to the transformer ratio working condition, improving the compressor performance.

The intermediate pressure servo mechanism

According to the operation pressure among dynamic adjusting middle pressure, has realized the axial flexible, optimization of dynamic vortex disk meshing, improve product performance.

High reliability of the bearing

Adopt cylinder bearing and self-aligning ball bearing bearing group, improving the reliability of the compressor.

Internal oil circulation structure

Lubricating oil to achieve internal circulation, reducing heat loss, decreasing the rate of spitting oil, improve the efficiency and reliability.

Positive displacement gear oil pump

Positive displacement gear oil pump to ensure the high and low frequency can satisfy the oil supply, improving the reliability of the compressor.

All-round Protection



Wide Operation Range

No matter in hot summer or cold winter, VXV 6 can supply comfortable environment for users.



Auto Dust Removal & Auto Snow-Blowing

The outdoor fan can rotate in reverse direction to remove dust on heat exchanger to ensure the heat exchange performance.



VXV 6 Series

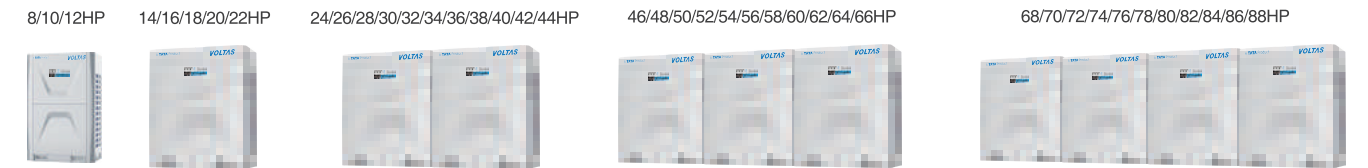

VXV 6 Series 380-415V-50Hz

HP			8	10	12	14
Model			VXV-H250/SR1MV	VXV-H280/SR1MV	VXV-H330/SR1MV	VXV-H400/SR1MV
Combination	HP		8	10	12	14
Capacity	Cooling	kW	25.2	28	33.5	40
	Heating	kW	25.2	28	33.5	40
Electric Data	Power supply	V~, Hz, Ph	380-415, 50/60, 3	380-415, 50/60, 3	380-415, 50/60, 3	380-415, 50/60, 3
	Air Flow Volume	m ³ /h	12000	12000	12000	14000
Performance	Sound Pressure level	dB(A)	≤58	≤58	≤58	≤61
	Type		DC inverter Scroll	DC inverter Scroll	DC inverter Scroll	DC inverter Scroll
Compressor	Quantity		1	1	1	1
	Type		DC motor	DC motor	DC motor	DC motor
Fan motor	Quantity		1	1	1	2
	Max. No. of Indoor Units	unit	13	16	20	23
Connection Ratio		%	50-200	50-200	50-200	50-200
	Dimension (WxDxH)	Net	mm	990×765×1635	990×765×1635	990×765×1635
Weight	Packing	mm	1030×825×1865	1030×825×1865	1030×825×1865	1395×825×1865
	Net	kg	215	215	230	265
Pipe Diameter	Gross	kg	225	225	240	280
	Liquid Side	mm	12.7	12.7	12.7	15.88
Operation Range	Gas Side	mm	22.2	22.2	22.2	28.6
	Cooling	°C	-5~52	-5~52	-5~52	-5~52
Stuffing Quantity	Heating	°C	-15~24	-15~24	-15~24	-15~24
	20/40/40H	unit	14/28/28	14/28/28	14/28/28	11/22/22

HP			16	18	20	22
Model			VXV-H450/SR1MV	VXV-H500/SR1MV	VXV-H560/SR1MV	VXV-H610/SR1MV
Combination	HP		16	18	20	22
Capacity	Cooling	kW	45	50.4	56	61.5
	Heating	kW	45	50.4	56	61.5
Electric Data	Power supply	V~, Hz, Ph	380-415, 50/60, 3	380-415, 50/60, 3	380-415, 50/60, 3	380-415, 50/60, 3
	Air Flow Volume	m ³ /h	14000	16000	16000	16000
Performance	Sound Pressure level	dB(A)	≤61	≤63	≤63	≤63
	Type		DC inverter Scroll	DC inverter Scroll	DC inverter Scroll	DC inverter Scroll
Compressor	Quantity		1	2	2	2
	Type		DC motor	DC motor	DC motor	DC motor
Fan motor	Quantity		2	2	2	2
	Max. No. of Indoor Units	unit	26	30	33	36
Connection Ratio		%	50-200	50-200	50-200	50-200
	Dimension (WxDxH)	Net	mm	1340×765×1635	1340×765×1635	1340×765×1635
Weight	Packing	mm	1395×825×1865	1395×825×1865	1395×825×1865	1395×825×1865
	Net	kg	265	330	330	330
Pipe Diameter	Gross	kg	280	345	345	345
	Liquid Side	mm	15.88	15.88	15.88	15.88
Operation Range	Gas Side	mm	28.6	28.6	28.6	28.6
	Cooling	°C	-5~52	-5~52	-5~52	-5~52
Stuffing Quantity	Heating	°C	-15~24	-15~24	-15~24	-15~24
	20/40/40H	unit	11/22/22	11/22/22	11/22/22	11/22/22

Notes:

- Cooling Capacity: Indoor temperature 27°C DB/19°C WB; Outdoor temperature: 35°C DB/ 24°C WB.
- Heating Capacity: Indoor temperature 20°C DB; Outdoor temperature: 7°C DB/ 6°C WB.
- Piping Length: Equivalent piping length: 7.5m, level difference: 0m.
- We can guarantee the operation only within 130% Combination. If you want to connect more than 130% combination, please contact us and discuss the requirement.
- Anechoic chamber conversion value, measured in test room. During actual operation. These values are normally somewhat higher as a result of ambient conditions.
- The above designs and specifications are subject to change without prior notice. Final specifications please refer to technical specification provided by sales representative.
- Sound values are measured in a semi-anechoic room, at a position 1m in front of the unit and 1.3m above the floor.
- The above combined types are factory-recommended type. Customized modular combination can be done at will.

VXV 6 Individual Series

22/24HP



26/28/30/32HP



HP			22	24	26	28	30	32
Model	Outdoor	50Hz	VXV-H620/5R1I	VXV-H670/5R1I	VXV-H730/5R1I	VXV-H780/5R1I	VXV-H850/5R1I	VXV-H900/5R1I
Capacity	Cooling	kW	61.5	67	73	78.5	85	90
	Heating	kW	69	75	81.5	87.5	95	100
Electric Data	Power supply	V~,Hz,Ph	380 ~415, 50, 3	380 ~415, 50, 3	380 ~415, 50, 3	380 ~415, 50, 3	380 ~415, 50, 3	380 ~415, 50, 3
	Air Flow Volume	m ³ /h	21000	21000	28000	28000	30000	30000
Performance	Sound Pressure level	dB(A)	≤63	≤63	≤65	≤65	≤65	≤65
	Type		DC inverter Scroll	DC inverter Scroll	DC inverter Scroll	DC inverter Scroll	DC inverter Scroll	DC inverter Scroll
Compressor	Quantity		2	2	2	2	2	2
Fan Motor	Quantity		2	2	2	2	2	2
Max. No. of Indoor Units	unit		36	39	43	46	50	53
Connection Ratio			50~130%	50~130%	50~130%	50~130%	50~130%	50~130%
Dimension (WxDxH)	Net	mm	1590×765×1600	1590×765×1600	2350×765×1600	2350×765×1600	2350×765×1600	2350×765×1600
	Packing	mm	1650×815×1770	1650×815×1770	2410×815×1770	2410×815×1770	2410×815×1770	2410×815×1770
Weight	Net	kg	400	400	500	500	500	500
	Gross	kg	420	420	515	515	515	515
Refrigerant Type			R410A	R410A	R410A	R410A	R410A	R410A
Pipe Diameter	Liquid Side	mm	15.88	15.88	19.05	19.05	19.05	19.05
	Gas Side	mm	28.6	28.6	34.9	34.9	34.9	34.9
Operation Range	Cooling	°C	-5~52	-5~52	-5~52	-5~52	-5~52	-5~52
	Heating	°C	-20~27	-20~27	-20~27	-20~27	-20~27	-20~27
Stuffing Quantity	20/40/40H	unit	7/14/14	7/14/14	4/8/8	4/8/8	4/8/8	4/8/8

Notes:
 1.Cooling Capacity: Indoor temperature 27°C DB/19°C WB; Outdoor temperature: 35°C DB/ 24°C WB.
 2.Heating Capacity:Indoor temperature 20°C DB; Outdoor temperature:7°C DB/ 6°C WB.
 3.Piping Length:Equivalent piping length: 7.5m, level difference: 0m.
 4.Anechoic chamber conversion value, measured in test room. During actual operation. These values are normally somewhat higher as a result of ambient conditions.
 5.The above designs and specifications are subject to change without prior notice. Final specifications please refer to technical specification provided by sales representative.
 6.Sound values are measured in a semi-anechoic room, at a position 1m in front of the unit and 1.3m above the floor,
 7.The above combined types are factory-recommended type.

VXV Mini Series

The outdoor units capacity range from 8kW to 28kW both in Single phase & 3 Phase which is ideal for small offices, villas, apartment and shops, making it perfect for commercial and residential application.

4.4 HP, 5 HP, 5.7 HP, 8 HP & 10 HP



All DC Inverter

Model	Outdoor		VXV-H080/NR1	VXV-H100/NR1	VXV-H120/NR1	VXV-H140/NR1	VXV-H160/NR1
Capacity	Cooling	kW	8.00	10.00	12.30	14.00	16.00
	Heating	kW	9.00	11.50	13.20	16.00	18.00
Electric Data	Power Supply	V~,Hz,Ph	220~240,50/60,1	220~240,50/60,1	220~240,50/60,1	220~240,50/60,1	220~240,50/60,1
Performance	Air Flow Volume	m ³ /h	4154	4154	7200	7200	7200
	Noise Level	dB(A)	56	57	57	57	57
Piping Limite	Level difference between IDU and ODU	m	30	30	30	30	50
	Level difference between IDU and IDU	m	10	10	15	15	15
	Between the first brance and the Farthest IDU	m	40	40	40	40	40
	Total Pipe length	m	100	100	250	300	300
Max. No. of Indoor Units	unit		4	5	6	6	7
Connection Ratio	%		50~130	50~130	50~130	50~130	50~130
Dimension (WxDxH)	Net	mm	970×395×803	970×395×803	940×340×1320	940×340×1320	940×340×1320
	Packing	mm	1090×480×855	1090×480×855	1080×430×1440	1080×430×1440	1080×430×1440
Weight	Net	kg	66	66	86	86	93
	Gross	kg	71	71	91	91	98
Refrigerant Type			R410A	R410A	R410A	R410A	R410A
Pipe Diameter	Liquid Side	mm(inch)	9.52(3/8)	9.52(3/8)	9.52(3/8)	9.52(3/8)	9.52(3/8)
	Gas Side	mm(inch)	15.88(5/8)	15.88(5/8)	15.88(5/8)	15.88(5/8)	19.05(3/4)
Operation Range	Cooling	°C	-15~49	-15~49	-15~49	-15~49	-15~49
	Heating	°C	-15~27	-15~27	-15~27	-15~27	-15~27
Stuffing Quantity	20/40/40H	unit	48/96/150	48/96/150	48/96/150	26/54/54	26/54/54

Model	Outdoor		VXV-H220/5NR1A	VXV-H280/5NR1A
Capacity	Cooling	kW	22.40	28.00
	Heating	kW	24.50	28.50
Electric Data	Power Supply	V~,Hz,Ph	380~415,50,3	380~415,50,3
Performance	Air Flow Volume	m ³ /h	15300	15300
	Noise Level	dB(A)	60	60
Piping Limit	Vertical Pipe Length	m	≤30	≤30
	Actual Pipe Length	m	45	45
	Equivalent Pipe Length	m	50	50
	Total Pipe length	m	100	100
Max. No. of Indoor Units	unit		11	12
Connection Ratio	%		50~130	50~130
Dimension (WxDxH)	Net	mm	1120×400×1510	1120×400×1510
	Packing	mm	1270×560×1710	1270×560×1710
Weight	Net	kg	150	150
	Gross	kg	170	170
Refrigerant Type			R410A	R410A
Pipe Diameter	Liquid Side	mm(inch)	9.52(3/8)	9.52(3/8)
	Gas Side	mm(inch)	22.22(7/8)	22.22(7/8)
Operation Range	Cooling	°C	-10~52	-10~52
	Heating	°C	-15~24	-15~24
Stuffing Quantity	20/40/40H	unit	17/37/37	17/37/37

Notes:
 1.Cooling Capacity: Indoor temperature 27°C DB/ 19°C WB; Outdoor temperature:35°C DB/ 24°C WB.
 2.Heating Capacity: Indoor temperature 20°C DB; Outdoor temperature: 7°C DB/ 6°C WB.
 3.Piping Length: Equivalent piping length: 7.5m, level difference: 0m.
 4.Anechoic chamber conversion value, measured in test room. During actual operation. These values are normally somewhat higher as a result of ambient c onditions.
 5.The above designs and specifications are subject to change without prior notice. Final specifications please refer to technical specification provided by sales representative.

VXV Series - Indoor Range



One Way Cassette

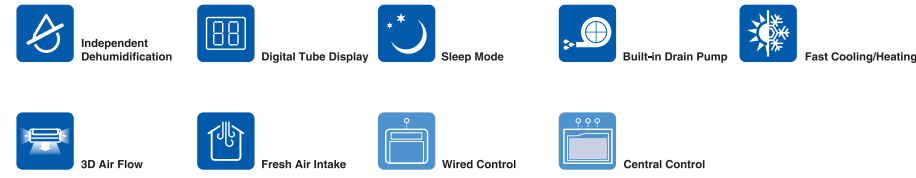

Model	Indoor		VXVC1-H028/4R1A	VXVC1-H036/4R1A	VXVC1-H045/4R1A	VXVC1-H056/4R1A	VXVC1-H071/4R1A
Capacity	Cooling	kW	2.8	3.6	4.5	5.6	7.1
	Heating	kW	3.2	4	5	6.3	8
Electric Data	Power Supply	V-, Hz, Ph	220-240, 50, 1	220-240, 50, 1	220-240, 50, 1	220-240, 50, 1	220-240, 50, 1
	Rated Power	W	40	40	45	45	50
Performance	Air Flow Volume(Hi/Mid/Low)	m ³ /h	510/410/310	600/480/360	720/570/450	910/830/700	1000/850/750
	Noise Level(Hi/Mid/Low)	dB (A)	36/34/30	38/28/26	42/39/35	45/41/39	47/43/40
Dimension (WxDxH)	Net(Body)	mm	870x460x250	870x460x250	870x460x250	1180x495x290	1180x495x290
	Packing(Body)	mm	1130x570x355	1130x570x355	1130x570x355	1440x660x385	1440x660x385
	Net(Panel)	mm	1070x520x33	1070x520x33	1070x520x33	1380x550x33	1380x550x33
	Packing(Panel)	mm	1085x555x175	1085x555x175	1085x555x175	1400x585x175	1400x585x175
Weight	Net/Gross(Body)	kg	25/32	27/34	27/34	39/46	39/46
	Net/Gross(Panel)	kg	3/5	3/5	3/5	5/7	5/7



Two Way Cassette

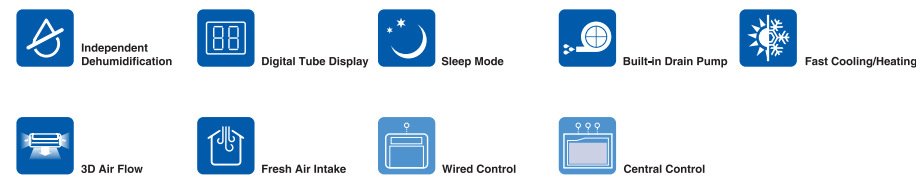

Model	Indoor		VXVC2-H028/4R1A	VXVC2-H036/4R1A	VXVC2-H045/4R1A	VXVC2-H056/4R1A	VXVC2-H071/4R1A
Capacity	Cooling	kW	2.8	3.6	4.5	5.6	7.1
	Heating	kW	3.2	4.0	5.0	6.3	8.0
Electric Data	Power Supply	V-, Hz, Ph	220-240, 50, 1	220-240, 50, 1	220-240, 50, 1	220-240, 50, 1	220-240, 50, 1
	Rated Power	W	60	62	68	85	94
Performance	Air Flow Volume(Hi/Mid/Low)	m ³ /h	550	620	780	900	1165
	Noise Level(Hi/Mid/Low)	dB (A)	36/32/29	36/32/29	39/35/30	39/35/30	43/39/36
Dimension (WxDxH)	Net(Body)	mm	840x520x315	840x520x315	960x520x315	960x520x315	1200x520x315
	Packing(Body)	mm	1145x685x395	1145x685x395	1265x685x395	1265x685x395	1505x685x395
	Net(Panel)	mm	1083x630x33	1083x630x33	1203x630x33	1203x630x33	1443x630x33
	Packing(Panel)	mm	1100x665x175	1100x665x175	1220x665x175	1220x665x175	1480x665x175
Weight	Net/Gross(Body)	kg	31/38	31/38	36/43	36/43	39/46
	Net/Gross(Panel)	kg	4.5/6.5	4.5/6.5	5/7	5/7	7.5/11.5



Compact Four Way Cassette



Model	Indoor		VXVCA-H028/R1X	VXVCA-H036/R1X	VXVCA-H045/R1X	VXVCA-H056/R1X
Capacity	Cooling	kW	2.8	3.6	4.5	5.6
	Heating	kW	3.0	4.3	5.0	6.0
Electric Data	Power Supply	V-, Hz, Ph	220-240, 50/60, 1	220-240, 50/60, 1	220-240, 50/60, 1	220-240, 50/60, 1
	Rated Power	W	33.5	33.5	33.5	33.5
Performance	Air Flow Volume(Hi/Mid/Low)	m ³ /h	700/600/530	700/600/530	700/600/530	700/600/530
	Noise Level(Hi/Mid/Low)	dB (A)	45/41/35	45/41/35	45/41/35	45/41/35
Dimension (WxDxH)	Net(Body)	mm	570x630x260	570x630x260	570x630x260	570x630x260
	Packing(Body)	mm	650x710x290	650x710x290	650x710x290	650x710x290
	Net(Panel)	mm	650x650x55	650x650x55	650x650x55	650x650x55
	Packing(Panel)	mm	710x710x80	710x710x80	710x710x80	710x710x80
Weight	Net/Gross(Body)	kg	19/21	19/21	19/21	19/21
	Net/Gross(Panel)	kg	3/5	3/5	3/5	3/5

Notes:
 1.Cooling Capacity: Indoor temperature 27°C DB/19°C WB; Outdoor temperature: 35°C DB/24°C WB.
 2.Heating Capacity: Indoor temperature 20°C DB; Outdoor temperature: 7°C DB/6°C WB.
 3.Piping Length: Equivalent piping length: 7.5m, l evel difference: 0m.
 4.Sound level is measured at 1.4m below the unit.
 5.The above designs and specifications are subject to change without prior notice. Final specifications please refer to technical specification provided by sales representative.

VXV Series - Indoor Range



Four Way Cassette

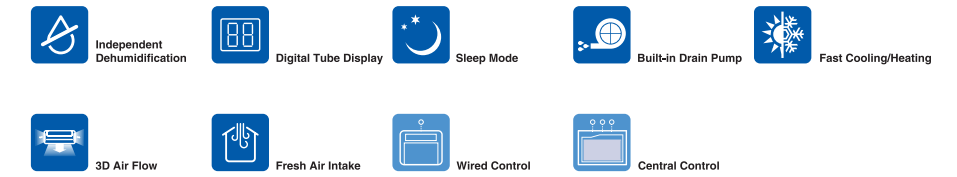

Model	Indoor		VXVCA-H071/4R1B	VXVCA-H080/4R1B	VXVCA-H090/4R1B	VXVCA-H100/4R1B
Capacity	Cooling	kW	7.1	8.0	9.0	10.0
	Heating	kW	8.0	10.0	11.0	12.0
Electric Data	Power Supply	V-, Hz, Ph	220-240, 50, 1	220-240, 50, 1	220-240, 50, 1	220-240, 50, 1
	Rated Power	W	100	100	176	176
Performance	Air Flow Volume(Hi/Mid/Low)	m ³ /h	1250/1040/910	1250/1040/910	1500/1200/1050	1500/1200/1050
	Noise Level(Hi/Mid/Low)	dB (A)	38/34/30	38/34/30	41/37/34	41/37/34
Dimension (WxDxH)	Net(Body)	mm	835x835x250	835x835x250	835x835x250	835x835x250
	Packing(Body)	mm	910x910x310	910x910x310	910x910x310	910x910x310
	Net(Panel)	mm	950x950x55	950x950x55	950x950x55	950x950x55
	Packing(Panel)	mm	1000x1000x100	1000x1000x100	1000x1000x100	1000x1000x100
Weight	Net/Gross(Body)	kg	27/34	27/34	28/35	28/35
	Net/Gross(Panel)	kg	5/7	5/7	5/7	5/7

Model	Indoor		VXVCA-H112/4R1B	VXVCA-H125/4R1B	VXVCA-H140/4R1B
Capacity	Cooling	kW	11.2	12.5	14.0
	Heating	kW	12.8	13.3	15.0
Electric Data	Power Supply	V-, Hz, Ph	220-240, 50, 1	220-240, 50, 1	220-240, 50, 1
	Rated Power	W	200	200	200
Performance	Air Flow Volume(Hi/Mid/Low)	m ³ /h	1800/1440/1260	1800/1440/1260	1800/1440/1260
	Noise Level(Hi/Mid/Low)	dB (A)	41/38/35	41/38/35	41/38/35
Dimension (WxDxH)	Net(Body)	mm	835x835x290	835x835x290	835x835x290
	Packing(Body)	mm	910x910x350	910x910x350	910x910x350
	Net(Panel)	mm	950x950x55	950x950x55	950x950x55
	Packing(Panel)	mm	1000x1000x100	1000x1000x100	1000x1000x100
Weight	Net/Gross(Body)	kg	30/37	30/37	30/37
	Net/Gross(Panel)	kg	5/7	5/7	5/7

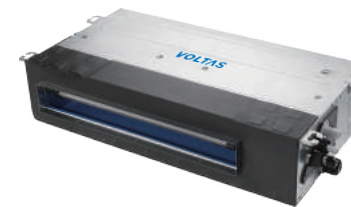

Low ESP Duct

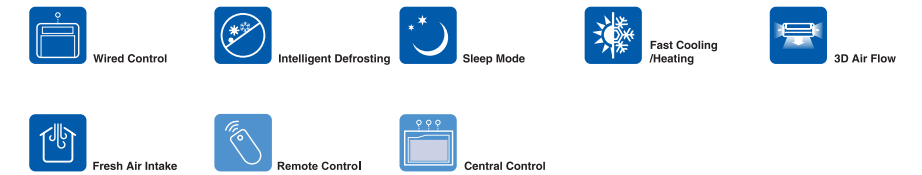

Model	Indoor		VXVSD-H022/4R1A	VXVSD-H028/4R1A	VXVSD-H036/4R1A	VXVSD-H045/4R1A	VXVSD-H056/4R1A	VXVSD-H071/4R1A
Capacity	Cooling	kW	2.2	2.8	3.6	4.5	5.6	7.1
	Heating	kW	2.5	3.0	4.3	5.0	6.0	8.0
Electric Data	Power Supply	V-, Hz, Ph	220-240, 50, 1	220-240, 50, 1	220-240, 50, 1	220-240, 50, 1	220-240, 50, 1	220-240, 50, 1
	Rated Power	W	59	59	65	91	91	113
Performance	Air Flow Volume(Hi/Mid/Low)	m ³ /h	480/390/320	480/390/320	560/430/390	850/680/575	850/680/575	1000/810/685
	Noise Level(Hi/Mid/Low)	dB (A)	30/26/23	30/26/23	32/28/25	38/35/32	38/35/32	39/36/32
Dimension (WxDxH)	External Static Pressure(ESP)	Pa	10/30	10/30	10/30	10/30	10/30	10/30
	Net(Body)	mm	840x460x185	840x460x185	840x460x185	1160x460x185	1160x460x185	1160x460x185
	Packing(Body)	mm	1030x545x250	1030x545x250	1030x545x250	1350x545x250	1350x545x250	1350x545x250
	Net(Gross(Body))	kg	15.5/19	15.5/19	16.5/20	20/24	20/24	22/26

Notes:
 1.Cooling Capacity: Indoor temperature 27°C DB/19°C WB; Outdoor temperature: 35°C DB/24°C WB.
 2.Heating Capacity: Indoor temperature 20°C DB; Outdoor temperature: 7°C DB/6°C WB.
 3.Piping Length: Equivalent piping length: 7.5m, l evel difference: 0m.
 4.Sound level is measured at 1.4m below the unit.
 5.The above designs and specifications are subject to change without prior notice. Final specifications please refer to technical specification provided by sales representative.

VXV Series - Indoor Range



Medium ESP Duct

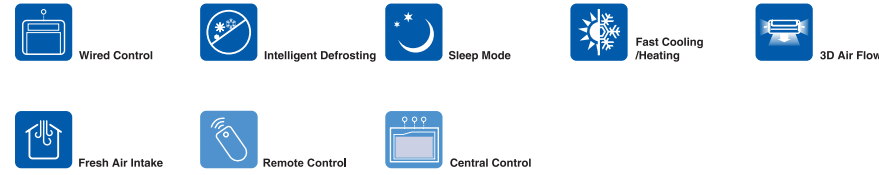

Model	Indoor		VXVMD-H045/4R1A	VXVMD-H056/4R1A	VXVMD-H071/4R1A	VXVMD-H080/4R1A	VXVMD-H090/4R1A
Capacity	Cooling	kW	4.5	5.6	7.1	8.0	9.0
	Heating	kW	5.0	6.0	8.0	10.0	11.0
Electric Data	Power Supply	V-, Hz, Ph	220-240,50,1	220-240,50,1	220-240,50,1	220-240,50,1	220-240,50,1
	Rated Power	W	100	100	160	160	160
Performance	Air Flow Volume (Hi/Mid/Low)	m ³ /h	950/850/700	950/850/700	1300/1100/850	1300/1100/850	1500/1200/1050
	Noise Level (Hi/Mid/Low)	dB (A)	40/37/33	40/37/33	41/39/36	41/39/36	44/41/39
	External Static Pressure (ESP)	Pa	50/80	50/80	50/80	50/80	50/80
Dimension (WxDxH)	Net(Body)	mm	890×735×290	890×735×290	890×735×290	890×735×290	890×735×290
	Packing(Body)	mm	1070×800×360	1070×800×360	1070×800×360	1070×800×360	1070×800×360
Weight	Net/Gross(Body)	kg	29.5/34	29.5/34	30.5/35	30.5/35	32.5/37

Model	Indoor		VXVMD-H100/4R1A	VXVMD-H112/4R1A	VXVMD-H125/4R1A	VXVMD-H140/4R1A	VXVMD-H150/4R1A
Capacity	Cooling	kW	10.0	11.2	12.5	14.0	15.0
	Heating	kW	12.0	12.8	13.3	15.0	16.0
Electric Data	Power Supply	V-, Hz, Ph	220-240,50,1	220-240,50,1	220-240,50,1	220-240,50,1	220-240,50,1
	Rated Power	W	180	180	240	240	240
Performance	Air Flow Volume (Hi/Mid/Low)	m ³ /h	1400/1200/950	2000/1700/1400	2000/1700/1400	2200/1850/1550	2200/1850/1550
	Noise Level (Hi/Mid/Low)	dB (A)	44/41/39	45/42/39	45/42/39	47/43/41	47/43/41
	External Static Pressure (ESP)	Pa	50/80	50/80	50/80	50/80	50/80
Dimension (WxDxH)	Net(Body)	mm	890×735×290	1250×735×290	1250×735×290	1250×735×290	1250×735×290
	Packing(Body)	mm	1070×800×360	1430×800×360	1430×800×360	1430×800×360	1430×800×360
Weight	Net/Gross(Body)	kg	32.5/37	42/47	42/47	42/47	42/47



High ESP Duct

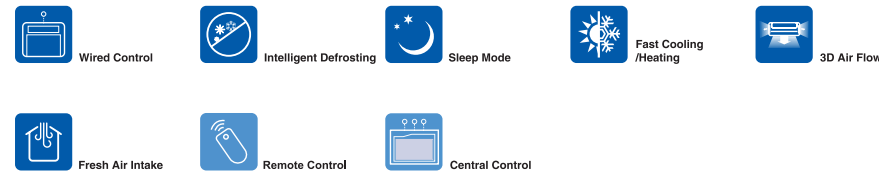

Model	Indoor		VXVHD-H112/4R1A	VXVHD-H125/4R1A	VXVHD-H140/4R1A	ACVXVHD-H150/4R1V	ACVXVHD-H190/4R1V
Capacity	Cooling	kW	11.2	12.5	14.0	15.0	19.3
	Heating	kW	12.8	13.3	15.0	16.0	21.5
Electric Data	Power Supply	V-, Hz, Ph	220-240,50,1	220-240,50,1	220-240,50,1	220-240,50,1	220-240,50,1
	Rated Power	W	600	600	600	600	900
Performance	Air Flow Volume (Hi/Mid/Low)	m ³ /h	2000/1600/1400	2000/1600/1400	2000/1600/1400	2890/2745/2600	3740/3553/3366
	Noise Level (Hi/Mid/Low)	dB (A)	48/46/44	48/46/44	48/46/44	50/48/47	51/49/48
	External Static Pressure (ESP)	Pa	196	196	196	196	196
Dimension (WxDxH)	Net	mm	1200×719×380	1200×719×380	1200×719×380	1130×750×475	1228×665×404
	Packing	mm	1235×760×415	1235×760×415	1235×760×415	1230×800×525	1328×715×454
Weight	Net/Gross	kg	56/59	56/59	56/59	58/83	65/90
	Liquid Side	mm(inch)	9.52(3/8)	9.52(3/8)	9.52(3/8)	12.7 (1/2)	12.7 (1/2)

Model	Indoor		VXVHD-H220/4R1B	VXVHD-H280/4R1B	ACVXVHD-H300/4R1V	ACVXVHD-H390/4R1V	ACVXVHD-H560/5R1V
Capacity	Cooling	kW	22.4	28.0	30.0	39.0	56.0
	Heating	kW	25.0	31.5	33.0	43.0	61.5
Electric Data	Power Supply	V-, Hz, Ph	220-240,50,1	220-240,50,1	220-240,50,1	220-240,50,1	380-415,50,3
	Rated Power	W	1250	1250	1400	1700	2500
Performance	Air Flow Volume (Hi/Mid/Low)	m ³ /h	4000/3200/2600	4000/3200/2600	5780/5491/5202	7480/7106/6732	11220/10659/10098
	Noise Level (Hi/Mid/Low)	dB (A)	51/49/48	52/50/49	52/50/49	53/51/49	53/51/49
	External Static Pressure (ESP)	Pa	220	220	280	280	280
Dimension (WxDxH)	Net	mm	1350×700×460	1350×700×460	1508×795×404	1820×780×475	2150×825×520
	Packing	mm	1540×810×610	1540×810×610	1608×845×454	1920×830×525	2250×875×570
Weight	Net/Gross	kg	91/110	91/110	90/115	110/135	180/205
	Liquid Side	mm(inch)	12.7(1/2)	12.7(1/2)	15.8 (5/8)	15.8 (5/8)	15.8 (5/8)

Notes:
 1.Cooling Capacity: Indoor temperature 27°C DB/19°C WB; Outdoor temperature: 35°C DB/24°C WB.
 2.Heating Capacity: Indoor temperature 20°C DB; Outdoor temperature: 7°C DB/6°C WB.
 3.Piping Length: Equivalent piping length: 7.5m, level difference: 0m.
 4.Sound level is measured at 1.4m below the unit.
 5.The above designs and specifications are subject to change without prior notice. Final specifications please refer to technical specification provided by sales representative.

VXV Series - Indoor Range



Wall Mounted



Model	Indoor		VXVWM-H022/4R1A(LH)	VXVWM-H028/4R1A(LH)	VXVWM-H036/4R1A(LH)	VXVWM-H045/4R1A(LH)	VXVWM-H056/4R1A(LH)	VXVWM-H071/4R1A(LH)
Capacity	Cooling	kW	2.2	2.8	3.6	4.5	5.6	7.1
	Heating	kW	2.5	3.0	4.3	5.0	6.0	8.0
Electric Data	Power Supply	V-, Hz, Ph	220-240,50,1	220-240,50,1	220-240,50,1	220-240,50,1	220-240,50,1	220-240,50,1
	Rated Power	W	38	38	38	68	68	82
Performance	Air Flow Volume (Hi/Mid/Low)	m ³ /h	650/600/580	650/600/580	650/600/580	850/750/650	850/750/650	1200/950/800
	Noise Level (Hi/Mid/Low)	dB (A)	38/33/27	38/33/27	38/33/27	45/41/35	45/41/35	48/45/39
Dimension (WxDxH)	Net	mm	850×300×198	850×300×198	850×300×198	970×315×235	970×315×235	1100×330×235
	Packing	mm	905×357×267	905×357×267	905×357×267	1010×370×300	1010×370×300	1140×385×300
Weight	Net/Gross	kg	10/13	10/13	10/13	14/18	14/18	16/20

Notes:
 1.Cooling Capacity: Indoor temperature 27°C DB/19°C WB; Outdoor temperature: 35°C DB/24°C WB.
 2.Heating Capacity: Indoor temperature 20°C DB; Outdoor temperature: 7°C DB/6°C WB.
 3.Piping Length: Equivalent piping length: 7.5m, level difference: 0m.
 4.Sound level is measured 1m below the air outlet horizontally and vertically.
 5.The above designs and specifications are subject to change without prior notice. Final specifications please refer to technical specification provided by sales representative.



Ceiling and Floor Mounted

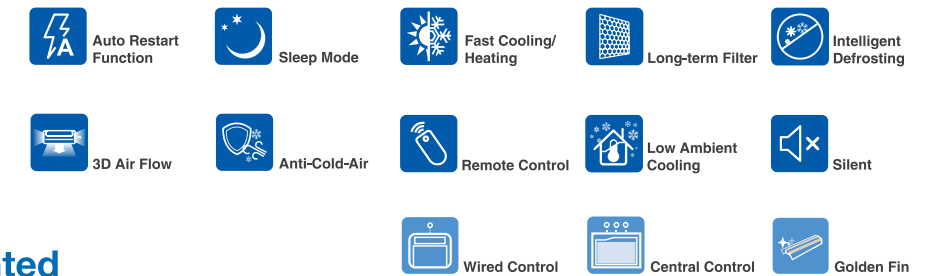

Model	Indoor		VXVCF-H028/4R1A	VXVCF-H036/4R1A	VXVCF-H045/4R1A	VXVCF-H056/4R1A	VXVCF-H071/4R1A	VXVCF-H080/4R1A
Capacity	Cooling	kW	2.8	3.6	4.5	5.6	7.1	8.0
	Heating	kW	3.0	4.3	5.0	6.0	8.0	10.0
Electric Data	Power Supply	V-, Hz, Ph	220-240,50,1	220-240,50,1	220-240,50,1	220-240,50,1	220-240,50,1	220-240,50,1
	Rated Power	W	80	80	80	80	140	140
Performance	SEER/SCOP (Hi/Mid/Low)	m ³ /h	450/360/315	630/504/441	950/760/665	950/760/665	1300/1040/910	1500/1200/1050
	Noise Level (Hi/Mid/Low)	dB (A)	37/34/31	39/36/33	42/39/36	42/39/36	45/42/39	47/44/41
Dimension (WxDxH)	Net(Body)	mm	929×660×205	929×660×205	929×660×205	929×660×205	1280×660×205	1280×660×205
	Packing(Body)	mm	1010×720×290	1010×720×290	1010×720×290	1010×720×290	1360×720×290	1360×720×290
Weight	Net/Gross(Body)	kg	26/29	26/29	26/29	26/29	35/39	35/39

Model	Indoor		VXVCF-H090/4R1A	VXVCF-H100/4R1A	VXVCF-H112/4R1A	VXVCF-H125/4R1A	VXVCF-H140/4R1A
Capacity	Cooling	kW	9.0	10.0	11.2	12.5	14.0
	Heating	kW	11.0	12.0	12.8	13.3	15.0
Electric Data	Power Supply	V-, Hz, Ph	220-240,50,1	220-240,50,1	220-240,50,1	220-240,50,1	220-240,50,1
	Rated Power	W	140	140	210	210	210
Performance	SEER/SCOP (Hi/Mid/Low)	m ³ /h	1500/1200/1050	1500/1200/1050	1800/1440/1260	1800/1440/1260	1800/1440/1260
	Noise Level (Hi/Mid/Low)	dB (A)	47/44/41	47/44/41	48/45/42	48/45/42	48/45/42
Dimension (WxDxH)	Net(Body)	mm	1280×660×205	1280×660×205	1631×660×205	1631×660×205	1631×660×205
	Packing(Body)	mm	1360×720×290	1360×720×290	1710×720×290	1710×720×290	1710×720×290
Weight	Net/Gross(Body)	kg	35/39	35/39	45/51	45/51	45/51

Notes:
 1.Cooling Capacity: Indoor temperature 27°C DB/19°C WB; Outdoor temperature: 35°C DB/24°C WB.
 2.Heating Capacity: Indoor temperature 20°C DB; Outdoor temperature: 7°C DB/6°C WB.
 3.Piping Length: Equivalent piping length: 7.5m, level difference: 0m.
 4.Floor standing: Sound level is measured 1m from air-outlet in horizontal distance, 1m above the floor in vertical distance.
 5.Ceiling mounted: Sound level is measured 1m from air-outlet in horizontal distance, 1m from air-outlet in vertical distance.
 6.The above designs and specifications are subject to change without prior notice. Final specifications please refer to technical specification provided by sales representative.

Fresh Air Processor

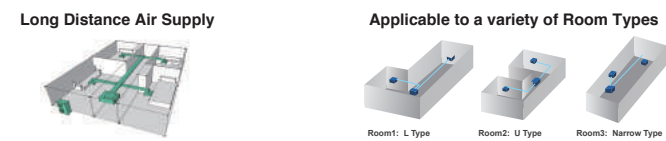
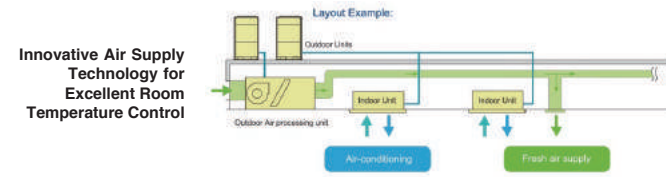

Specification-50Hz AC fan motor

Model	Indoor		VXVFA-H220/4R1B	VXVFA-H280/4R1B	VXVFA-H450/5R1A	VXVFA-H560/5R1A
Capacity	Cooling	kW	22.4	28.0	45.0	56.0
	Heating	kW	18.0	22.0	49.5	61.5
Electric Data	Power Supply	V~, Hz, Ph	220~240, 50, 1	220~240, 50, 1	380~415, 50, 3	380~415, 50, 3
	Rated Power	W	1000	1000	1520	1520
Performance	Air Flow Volume(Hi/Mid/Low)	m ³ /h	3200	3200	4000	5000
	Noise Level(Hi/Mid/Low)	dB(A)	55	55	57	59
	External Static Pressure(ESP)	Pa	220	220	220	220
Dimension (WxDxH)	Net	mm	1350×700×460	1350×700×460	1820×990×855	2115×990×855
	Packing	mm	1540×810×610	1540×810×610	1935×1025×1015	2225×1025×1015
Weight	Net/Gross	kg	91/110	91/110	150/170	225/255
	Liquid Side	mm(inch)	12.7(1/2)	12.7(1/2)	12.7(1/2)x2	12.7(1/2)x2
Pipe Diameter	Gas Side	mm(inch)	22.2(7/8)	22.2(7/8)	22.2(7/8)x2	22.2(7/8)x2
	Drainage	mm	DN25	DN25	DN25	DN25
Stuffing Quantity	20/40/40H	unit	30/63/84	30/63/84	10/22/22	10/22/22

Notes:
 1. Cooling Capacity: Indoor temperature 27°C DB/ 19°C WB; Outdoor temperature: 35°C DB/ 24°C WB. & Heating Capacity: Indoor temperature 20°C DB; Outdoor temperature: 7°C DB/ 6°C WB.
 2. Piping Length: Equivalent piping length: 7.5m, level difference: 0m. & Sound level is measured at 1.4m below the unit.
 3. The above designs and specifications are subject to change without prior notice. Please refer to the final technical specifications provided by sales representative.
Connection Conditions:
 1. The following restrictions must be observed in order to maintain the indoor units connected to the same system.
 2. When outdoor-air processing units are connected, the total connection capacity must be within 50% to 100% of that of the outdoor units.
 3. When outdoor-air processing units are standard indoor units are connected, the total connection capacity of the outdoor-processing units must not exceed 30% of that of the outdoor units.
 4. Outdoor-air processing units can be used without indoor units.

VXV Series - Controls & Accessories

Centralized Touch Screen Controllers



- Touch screen centralized control
- Multi system control
- Multiple lock function
- Weekly schedule control
- Indoor units operation status display
- Flexible wiring
- Keyboard Locking

AHU Kit



Overall Structure

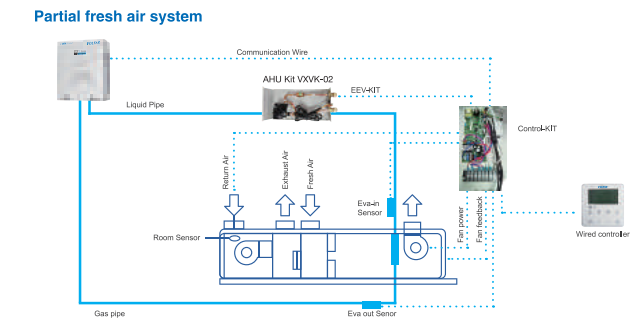

All fresh air system

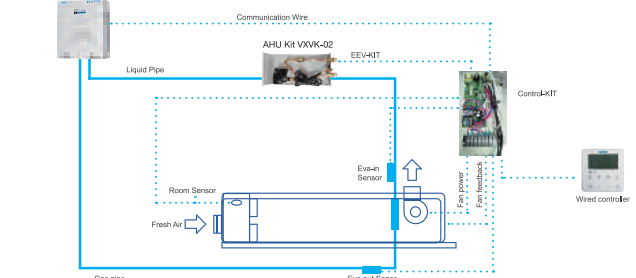

VXV Series - Controls & Accessories

Remote Controllers (YK-L)

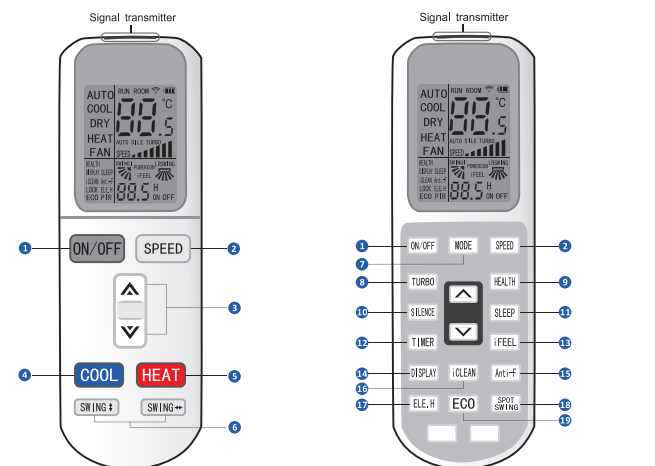

- 1 ON/OFF
- 2 Fan Speed Setting HIGH/MED/LOW/AUTO
- 3 Temperature-Setting/Timer Range Setting
- 4 Cooling Mode
- 5 Heating Mode
- 6 Vertical Swing/Horizontal Swing
- 7 Mode Setting AUTO/COOL/DRY/HEAT/FAN
- 8 Turbo Wind
- 9 Health Function
- 10 Silence Function
- 11 Sleep Function
- 12 Timer On/Off
- 13 I Feel Function
- 14 LED Display On/Off
- 15 Anti-fungus Function
- 16 Clean Function
- 17 Auxiliary Electric Heating
- 18 Spot Swing
- 19 Economic Function

*YK-L -for commissioning

Remote Controller (YK-K)

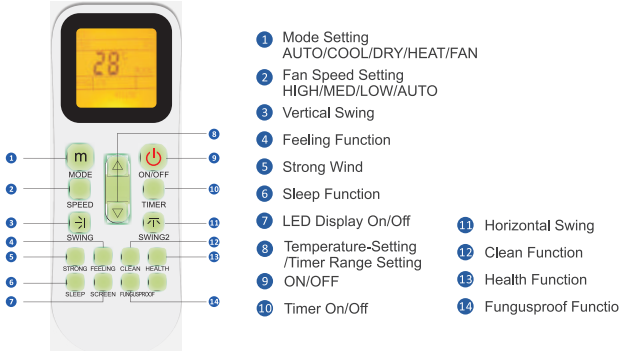

Wired Controller (XK-05A)

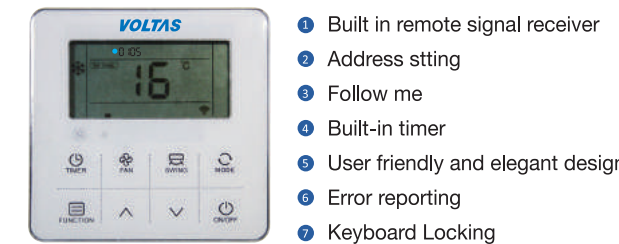

- 1 Mode Setting AUTO/COOL/DRY/HEAT/FAN
- 2 Fan Speed Setting HIGH/MED/LOW/AUTO
- 3 Vertical Swing
- 4 Feeling Function
- 5 Strong Wind
- 6 Sleep Function
- 7 LED Display On/Off
- 8 Temperature-Setting/Timer Range Setting
- 9 ON/OFF
- 10 Timer On/Off
- 11 Horizontal Swing
- 12 Clean Function
- 13 Health Function
- 14 Fungusproof Function
- 1 Built in remote signal receiver
- 2 Address stting
- 3 Follow me
- 4 Built-in timer
- 5 User friendly and elegant design
- 6 Error reporting
- 7 Keyboard Locking

VXV Series - Network Control

Network Control Software

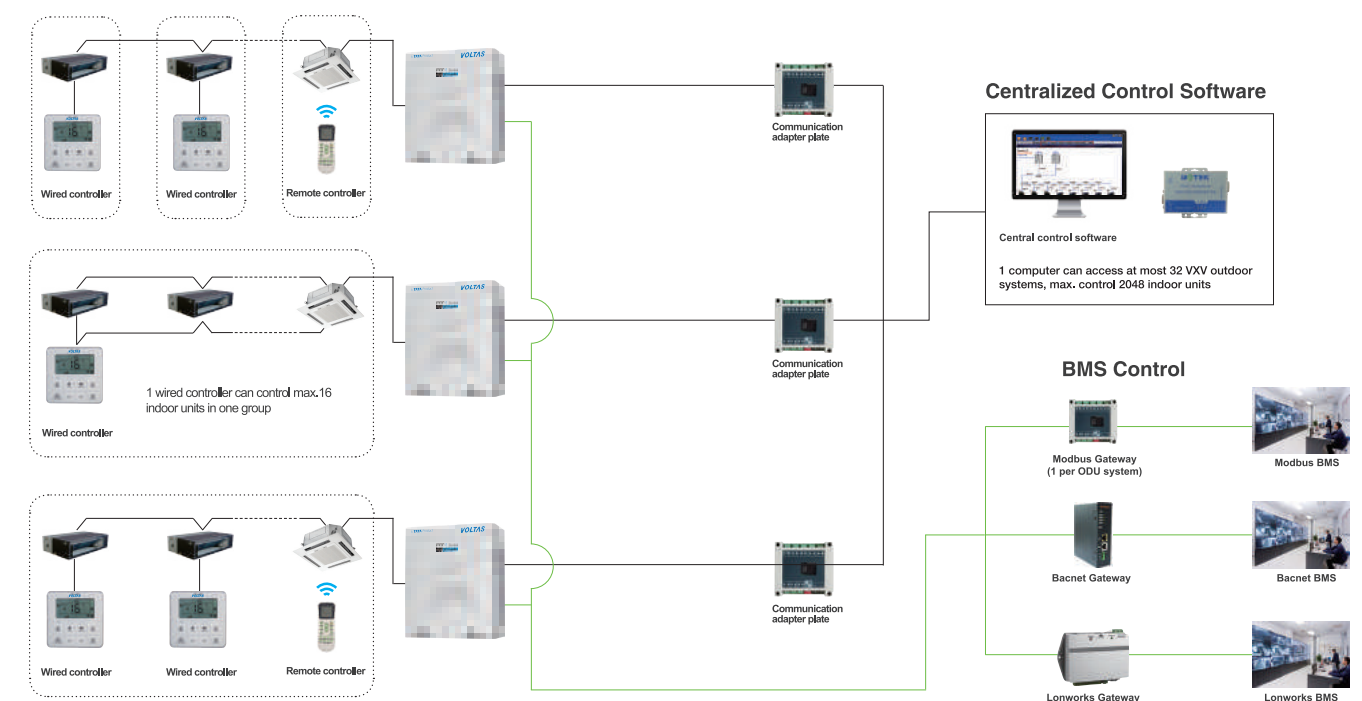

Voltas Customer Care Life Cycle Support

Through **MANAGED** Services

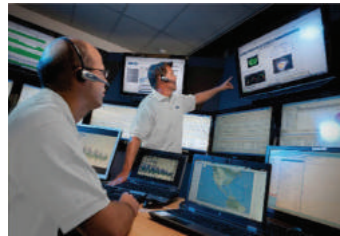

Remote Monitoring



Digital Service Reports



24x7 Helpdesk

**Voltas is 'Grade 1'
Energy Service Company (ESCO)**

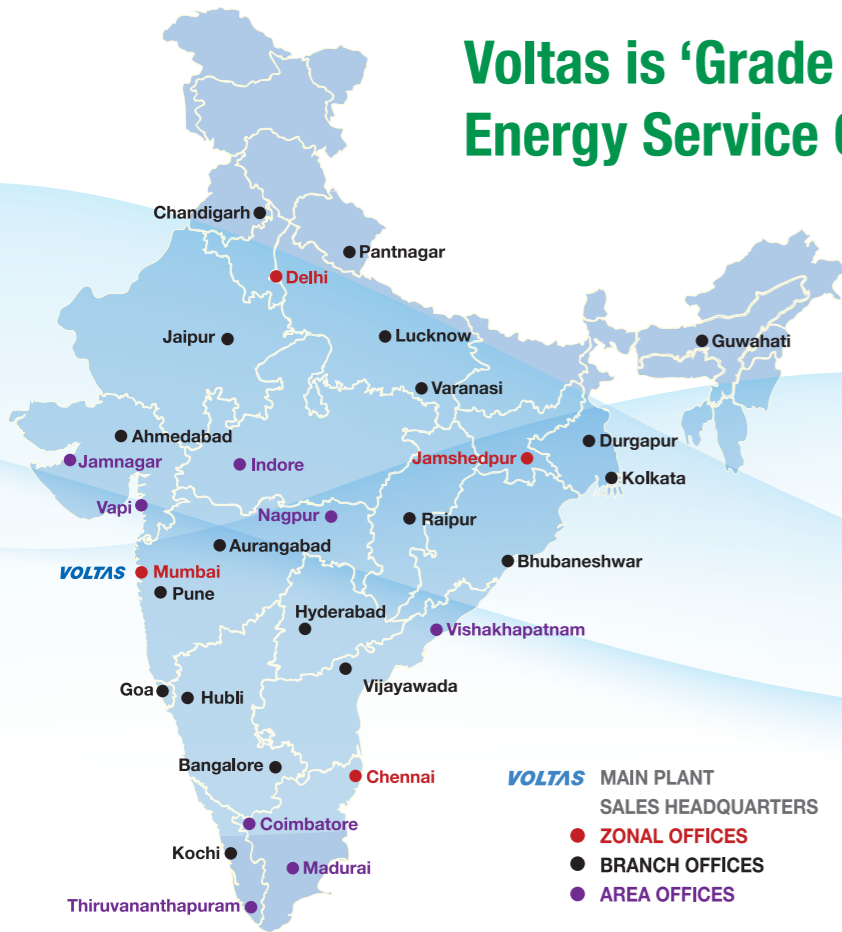

Voltas National Network
Easy Access • Quick Satisfaction

Customer Care
9100660100

MEP Services :

- Electro-mechanical Services
- HVAC
- Refrigeration

Water and Wastewater Management

Value Added Services

- VOLTAS** MAIN PLANT
SALES HEADQUARTERS
- ZONAL OFFICES
 - BRANCH OFFICES
 - AREA OFFICES



VOLTAS LIMITED
Domestic Projects Group, Voltas House 'B', 3rd floor, T. B. Kadam Marg, Chinchpokli, Mumbai-400 033, India
Tel: +91 22 6665 6857. Email: bijogeorge@voltas.com, jatinpanchal@voltas.com, shubhambahadkar@voltas.com,
North: psnorth@voltas.com, East: pseast@voltas.com, South: psouth@voltas.com, West: pswest@voltas.com
Website: www.voltas.com

NORTH ZONE: DELHI (011) 66505659/66505678/66505680/66505657 **CHANDIGARH** (0172) 4111800 **JAIPUR** (0141) 6541011 **LUCKNOW** 8840739788 **EAST ZONE:** KOLKATA (033) 66266268 / 662662283 / 66266262 **BHUBANESHWAR** (0674) 2747868 **PATNA** (0612) 2500786 **RAIPUR** (077) 14033886 **WEST ZONE:** MUMBAI (022) 66656754/ 66656756 / 66656757 / 66656759 / 66656760 **NAGPUR** (0712) 6456894 **AHMEDABAD** (079) 66301102 / 6630 1107 **PUNE** (020) 66297446 **INDORE** (0731) 2498616 **SOUTH ZONE:** CHENNAI (044) 66762357 / 66760346 / 66760355 **BENGALURU** (080) 22535648 **HYDERABAD** (040) 66743007 **COCHIN** (0484) 6605527.

India's Largest Air Conditioning Company



The Voltas VRF System

vVX Series

With World's Largest Single System Capacity



Outdoor Units - Upto 102 HP
Single Largest Module up to 34 HP

VL/VVX/mini/02/2020

PROFILE

Voltas, a member of the Tata Group, is India's No.1 air conditioning company and one of the world's premier engineering solutions providers and project specialists.

Founded in India in 1954, Voltas Limited offers premier cooling and **engineering solutions** for a wide spectrum of industries in areas such as **heating, ventilation and air conditioning, refrigeration, electro-mechanical projects, textile machinery, mining and construction equipment, water management & treatment, cold chain solutions, building management systems, electrification and indoor air quality.**

The Company's strengths lies principally in:

- Management and execution of electro-mechanical projects, Including **air conditioning** and **refrigeration**
- Sourcing, installation and servicing of diverse technology-based systems serving Indian industry through representation of global technology leaders

Organization

Voltas' operations have been organized into three independent business-specific clusters. Each of these has its own facilities for market coverage and service to customers.

Unitary Cooling Products

Air Conditioners

Commercial Refrigeration

Water Coolers & Dispensers

Domestic Projects Group

Electrical, Mechanical & Refrigeration Solutions

Electrical & Mechanical Solutions (international)

Electrical Projects Business - focusing on Rural Electrification (Distribution / Improvement)

Water Management Business Division - Large Capacity STP (MLD), Effluent treatment, Rural Water Supply Scheme.

Customer Care - Life Cycle Management through managed services

Engineering Products and Services

Textile Machinery

Mining & Construction Equipment

Projects

Over the years, Voltas has built up a substantial reputation and is actively engaged in **turnkey projects** in fields such as electro-mechanical works comprising **HVAC, electrical systems for buildings, plumbing, fire fighting, ELV and specialized systems, building security and other Utilities, electrical power projects, environmental and water pollution control, pumping stations and water supply, and water and waste water treatment projects.**

The Company has ISO 9001 - 2008 standards certification in its projects businesses, and has successfully undertaken and executed prestigious high-value projects in the Middle East, Far East and South East Asia, CIS countries, Africa and India.

Manufacturing

With state-of-the-art Manufacturing facilities at Vadodara, Thane, Dadra and Pantnagar, Voltas possesses total capability in the manufacturing of **room air conditioners, commercial air-conditioning and refrigeration equipment, water coolers, commercial refrigerators, visicoolers** etc.

Also, we have forayed into home appliances segment under the new brand **Voltbek Home Appliances Pvt. Ltd.** by launching **refrigerators, washing machines, microwave ovens and dishwashers** with our new manufacturing unit coming up at Sanand, Gujrat.

Sales & service

Voltas' sales and service operations cover:

- in-house manufactured products, including **air conditioning equipment and unitary cooling products**
- Products of principals represented, including **textile machinery and mining and construction equipment** In all these sectors, the company demonstrates its specialised engineering expertise, as well as its extensive network for global sourcing.

VVX Technology Features

Voltas presents latest VVX series VRF system with world's largest single system capacity and All DC inverter drives.

High efficiency EVI compressor

The enhanced vapour injection DC inverter compressor in the VVX Series increases refrigerant circulation and improves cooling capacity by more than 10%.

Lower pressure drop, lower noise

The grilles of fan air inlet and fan air outlet have an airflow direction adjusting function, which leads to lower pressure loss & lower noise.

Double Back up Operation

Compressor Backup - If one compressor fails, the other compressor can handle the load upto 4 days without affecting the comfort.
Unit Backup - In a multi-unit system, if one module fails, the other modules provide backup to keep the system running.

Wide Operation range

The VVX VRF can operate stably in a wide ambient temperature range from -5°C to 54°C in cooling mode and from -25°C to 24°C in heating mode.

Precise temperature control

Double electronic expansion valve arrangement can achieve upto 960 steps refrigerant flow control to get the best refrigerant distribution effect.

Industry highest Single module

Starting at 8HP, single largest module goes upto 34HP with capacity increments of 2HP.

Anti- corrosion protection

All the major parts of ODU like Fan motor, Screws/bolts/gaskets, Sheet metal frame, Heat exchanger, Control box case are given anti-corrosion treatment as standard and it can also be customized with heavy anti-corrosion treatment for surface protection against corrosive air, acid rain and saline air.

High efficiency G-type Heat exchanger

26-34HP units have a high efficiency 3-row G-type heat exchanger with a heat exchange area 1.5 times that of the 24HP unit. The 26-34HP units also have a super big size fan which has diameter is up to 750mm.

Wide capacity range

VVX modular series outdoors can be combined freely upto 102 HP with maximum 3 modules in single circuit.



DLF - Belaire, Gurgaon

Mindtree, Hyderabad

Ackruti VIVA, Mumbai



VVX MODULAR SERIES - Specifications



HP	8		10		12		14	
Model name	VVX-252WV2GN1		VVX-280WV2GN1		VVX-335WV2GN1		VVX-400WV2GN1	
Power supply	V/Ph/Hz		380-415/3/50(60)					
Cooling ¹	Capacity	kW	25.2	28.0	33.5	40.0		
		kBtu/h	86.0	95.5	114.3	136.5		
Heating ²	Capacity	kW	27.0	31.5	37.5	45.0		
		kBtu/h	92.1	107.5	128.0	153.5		
Connected indoor unit	Total capacity		50-130% of outdoor unit capacity					
	Maximum quantity		13	16	20	23		
Compressors	Type		DC inverter					
	Quantity		1					
Fan motors	Type		DC					
	Quantity		1					
Refrigerant	Static pressure		Pa		0-20 (default); 20-60 (customized)			
	Type		R410A					
Pipe connections ³	Factory charge		kg					
	Type		11					
Air flow rate	Liquid pipe		mm		Φ12.7		Φ15.9	
	Gas pipe		mm		Φ25.4		Φ28.6	
Sound pressure level ⁴	dB(A)		58	58	60	60		
Net dimensions (W×H×D)	mm		990×1635×790					
Packed dimensions (W×H×D)	mm		1090×1805×860					
Net weight	kg		227					
Gross weight	kg		242					
Ambient temp. operation range	Cooling		°C		-5 ~ 54			
	Heating		°C		-25 ~ 24			

HP	16		18		
Model name	VVX-450WV2GN1		VVX-500WV2GN1		
Power supply	V/Ph/Hz		380-415/3/50(60)		
Cooling ¹	Capacity	kW	45.0	50.0	
		kBtu/h	153.5	170.6	
Heating ²	Capacity	kW	50.0	56.0	
		kBtu/h	170.6	191.1	
Connected indoor unit	Total capacity		50-130% of outdoor unit capacity		
	Maximum quantity		26	29	
Compressors	Type		DC inverter		
	Quantity		1		
Fan motors	Type		DC		
	Quantity		1		
Refrigerant	Static pressure		Pa		0-20 (default); 20-60 (customized)
	Type		R410A		
Pipe connections ³	Factory charge		kg		
	Type		13		
Air flow rate	Liquid pipe		mm		Φ15.9
	Gas pipe		mm		Φ31.8
Sound pressure level ⁴	dB(A)		60	61	
Net dimensions (W×H×D)	mm		1340×1635×850		
Packed dimensions (W×H×D)	mm		1405×1805×910		
Net weight	kg		277		
Gross weight	kg		304		
Ambient temp. operation range	Cooling		°C		
	Heating		°C		

Notes:
 1. Indoor temperature 27°C DB, 19°C WB; outdoor temperature 35°C DB; equivalent refrigerant piping length 7.5m with zero level difference.
 2. Indoor temperature 20°C DB; outdoor temperature 7°C DB, 6°C WB; equivalent refrigerant piping length 7.5m with zero level difference.
 3. Diameters given are those of the unit's stop valve.
 4. Sound pressure level is measured at a position 1m in front of the unit and 1.3m above the floor in a semi-anechoic chamber.

VVX MODULAR SERIES - Specifications

Long Piping Length

- Total piping length: 1000m
- Longest piping length – actual (equivalent): 175m (200m)
- Longest piping length after first branch: 40/90*m
- Level difference between IDUs and ODU – ODU above (below): 90m (110m)
- Level difference between IDUs: 30m

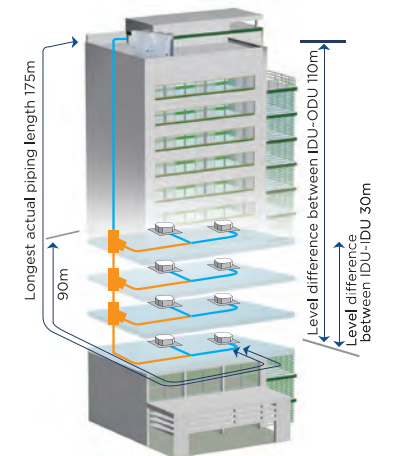

*The longest length after first branch is 40m as standard but can be extended to up to 90m under certain conditions. Please contact your local Voltas dealer for further information.

HP	20		22		24		26	
Model name	VVX-560WV2GN1		VVX-615WV2GN1		VVX-670WV2GN1		VVX-730WV2GN1	
Power supply	V/Ph/Hz		380-415/3/50(60)					
Cooling ¹	Capacity	kW	56.0	61.5	67.0	73.0		
		kBtu/h	191.1	209.8	228.6	249.1		
Heating ²	Capacity	kW	63.0	69.0	75.0	81.5		
		kBtu/h	215.0	235.4	255.9	278.1		
Connected indoor unit	Total capacity		50-130% of outdoor unit capacity					
	Maximum quantity		33	36	39	43		
Compressors	Type		DC inverter					
	Quantity		2					
Fan motors	Type		DC					
	Quantity		2					
Refrigerant	Static pressure		Pa		0-20 (default); 20-60 (customized)			
	Type		R410A					
Pipe connections ³	Factory charge		kg		17			
	Type		22					
Air flow rate	Liquid pipe		mm		Φ19.1		Φ22.2	
	Gas pipe		mm		Φ31.8		Φ31.8	
Sound pressure level ⁴	dB(A)		62	63	63	64		
Net dimensions (W×H×D)	mm		1340×1635×825				1730×1830×850	
Packed dimensions (W×H×D)	mm		1405×1805×910				1800×2000×910	
Net weight	kg		348				430	
Gross weight	kg		368				453	
Ambient temp. operation range	Cooling		°C		-5 ~ 54			
	Heating		°C		-25 ~ 24			

HP	28		30		32		34	
Model name	VVX-785WV2GN1		VVX-850WV2GN1		VVX-900WV2GN1		VVX-950WV2GN1	
Power supply	V/Ph/Hz		380-415/3/50(60)					
Cooling ¹	Capacity	kW	78.5	85.0	90.0	95.0		
		kBtu/h	267.8	290.0	307.1	324.1		
Heating ²	Capacity	kW	87.5	95.0	100.0	106.0		
		kBtu/h	298.6	324.1	341.2	361.7		
Connected indoor unit	Total capacity		50-130% of outdoor unit capacity				50-130% of outdoor unit capacity	
	Maximum quantity		46	50	53	56		
Compressors	Type		DC inverter					
	Quantity		2					
Fan motors	Type		DC					
	Quantity		2					
Refrigerant	Static pressure		Pa		0-20 (default); 20-60 (customized)			
	Type		R410A					
Pipe connections ³	Factory charge		kg		22			
	Type		25					
Air flow rate	Liquid pipe		mm		Φ22.2		Φ22.2	
	Gas pipe		mm		Φ31.8		Φ38.1	
Sound pressure level ⁴	dB(A)		64		64			
Net dimensions (W×H×D)	mm		1730×1830×850				1730×1830×850	
Packed dimensions (W×H×D)	mm		1800×2000×910				1800×2000×910	
Net weight	kg		430				475	
Gross weight	kg		453				507	
Ambient temp. operation range	Cooling		°C		-5 ~ 54			
	Heating		°C		-25 ~ 24			

Notes:
 1. Indoor temperature 27°C DB, 19°C WB; outdoor temperature 35°C DB; equivalent refrigerant piping length 7.5m with zero level difference.
 2. Indoor temperature 20°C DB; outdoor temperature 7°C DB, 6°C WB; equivalent refrigerant piping length 7.5m with zero level difference.
 3. Diameters given are those of the unit's stop valve.
 4. Sound pressure level is measured at a position 1m in front of the unit and 1.3m above the floor in a semi-anechoic chamber.

VX-i NON MODULAR SERIES - Specifications

Long Piping Length

- Total piping length: 1000m
- Longest piping length – actual (equivalent): 175m (200m)
- Longest piping length after first branch: 40/90*m
- Level difference between IDUs and ODU – ODU above (below): 90m (110m)
- Level difference between IDUs: 30m



*The longest length after first branch is 40m as standard but can be extended to up to 90m under certain conditions. Please contact your local Voltas dealer for further information.

HP	22		24	
Model name	VVX-i615WV2GN1		VVX-i670WV2GN1	
Power supply	V/Ph/Hz	380-415/3/50(60)		
Cooling ¹	Capacity	kW	61.5	67.0
		kBtu/h	209.8	228.6
Heating ²	Capacity	kW	69.0	75.0
		kBtu/h	235.4	255.9
Connected indoor unit	Total capacity	50-130% of outdoor unit capacity		
	Maximum quantity	36		39
Compressors	Type	DC inverter		
	Quantity	2		
Fan motors	Motor type	DC		
	Quantity	2		
Refrigerant	Static pressure	Pa		
	Type	R410A		
Pipe connections ³	Liquid pipe	mm		
	Gas pipe	mm		
Air flow rate	m ³ /h	17000		
Sound pressure level ⁴	dB(A)	63		
Net dimensions (W×H×D)	mm	1340×1635×825		
Packed dimensions (W×H×D)	mm	1405×1805×910		
Net weight	kg	344		
Gross weight	kg	364		
Ambient temp. operation range	Cooling	°C		
	Heating	°C		

HP	26	28	30	32	34		
Model name	VVX-i730WV2GN1	VVX-i785WV2GN1	VVX-i850WV2GN1	VVX-i900WV2GN1	VVX-i950WV2GN1		
Power supply	V/Ph/Hz	380-415/3/50(60)					
Cooling ¹	Capacity	kW	73.0	78.5	85.0	90.0	95.0
		kBtu/h	249.1	267.8	290.0	307.1	324.1
Heating ²	Capacity	kW	81.5	87.5	95.0	100.0	106.0
		kBtu/h	278.1	298.6	324.1	341.2	361.7
Connected indoor unit	Total capacity	50-130% of outdoor unit capacity					
	Maximum quantity	43	46	50	53	56	
Compressors	Type	DC inverter					
	Quantity	2					
Fan motors	Motor type	DC					
	Quantity	2					
Refrigerant	Static pressure	Pa					
	Type	R410A					
Pipe connections ³	Liquid pipe	mm					
	Gas pipe	mm					
Air flow rate	m ³ /h	25000			24000		
Sound pressure level ⁴	dB(A)	64					
Net dimensions (W×H×D)	mm	1730×1830×850					
Packed dimensions (W×H×D)	mm	1800×2000×910					
Net weight	kg	407	429		475		
Gross weight	kg	430	452		507		
Ambient temp. operation range	Cooling	°C					
	Heating	°C					

- Notes:
1. Indoor temperature 27°C DB, 19°C WB; outdoor temperature 35°C DB; equivalent refrigerant piping length 7.5m with zero level difference.
 2. Indoor temperature 20°C DB; outdoor temperature 7°C DB, 6°C WB; equivalent refrigerant piping length 7.5m with zero level difference.
 3. Diameters given are those of the unit's stop valve.
 4. Sound pressure level is measured at a position 1m in front of the unit and 1.3m above the floor in a semi-anechoic chamber.

WATER COOLED SERIES

The outdoor units capacity ranges from 8HP up to 36HP. Maximum 59 indoor units with up to 130% of total capacity of outdoor units can be connected in one refrigeration system.



Long Piping Length

			Permitted value
Total pipe length*(Actual)			300m
Piping Length	Maximum piping(L)	Actual length	120m
		Equivalent length	150m
	Equivalent piping length from the farthest IDU to the first indoor branch joint		40m/90m*
Level difference between IDU & ODU	Outdoor unit up	50m	
	Outdoor unit down	40m	
Level difference between IDU~IDU			30m

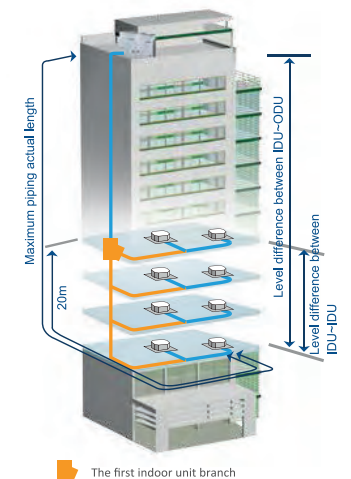

*Total pipe length is equal to two times blue pipe length plus orange pipe length.
 *When the farthest pipe length is more than 40m. It needs to meet the specific condition according to the installation part of the technical manual.

Specifications

Model	VDVS-252(8)W/DRN1		VDVS-280(10)W/DRN1		VDVS-335(12)W/DRN1		
Power supply	V/Ph/Hz	380~415/3/50		380~415/3/50		380~415/3/50	
Capacity	Cooling	kW/HP		25.2/8		28.0/10	
	Heating	kW		27.0		31.5	
Indoor unit connectable capacity range	%	50-130		50-130		50-130	
Maximum connectable indoor units	nos.	13		16		20	
Compressor (DC Inverter)	Type	Scroll		Scroll		Scroll	
	Quantity	01		01		01	
Sound pressure level	dB(A)	51		52		52	
Unit Dimension	Net (W x H x D)	mm		780×1000×550		780×1000×550	
	Gross (W x H x D)	mm		845×1170×600		845×1170×600	
Weight	Net / Gross	kg		146/155		146/155	
	Refrigerant	Type	R410A		R410A		R410A
Refrigerant Line	Liquid	mm		Ø12.7		Ø15.9	
	Gas	mm		Ø25.4		Ø31.8	
	Oil balance	mm		Ø6.35		Ø6.35	
Water side connection pipe	mm	DN32 inner groove		DN32 inner groove		DN32 inner groove	
Drainage pipe outside diameter	mm	Ø10.0		Ø10.0		Ø10.0	
Condensor	Rated water flow	m ³ /h		5.4		6.0	
	Water in temperature	°C		7-45		7-45	
	Max. Pressure drop	kPa		35		40	

Notes:
 Capacities are based on the following conditions:
 Cooling: Indoor temperature 27°C DB/19°C WB; Main unit ambient temperature 35°C DB/24°C WB; Water inlet temperature 30°C.
 Heating: Indoor temperature 20°C DB/15°C WB; Main unit ambient temperature 7°C DB/6°C WB; Water inlet temperature 20°C.

Connection piping diameter of multi-unit is the main pipe connecting to the first indoor branch joint, is case of the total equivalent liquid length is less than 90 m. If the total equivalent liquid length is more than 90 m, please refer to technical manual to choose the connection piping diameter.

Sound values are measured in a semi-anechoic room, at a position 1m in front of the unit and 1m above the floor.

MINI VRF SERIES - Cooling Only

Wide Capacity Range

The outdoor units' comprising of all DC Inverter Compressors and DC Fan Motors, are available in the capacity ranging from 7.2kW to 17kW which is ideal for small offices, villas, apartments and shops, making it perfect for commercial and residential application.



7.2kW, 9.2kW, 11kW



14.5kW, 17kW

Long Piping Length

The Mini VRF provides a total piping length possibility of 100m, a maximum height difference between outdoor and indoor units of 30m. The height difference between indoor units can be up to 8m. These generous allowances facilitate an extensive array of system designs.

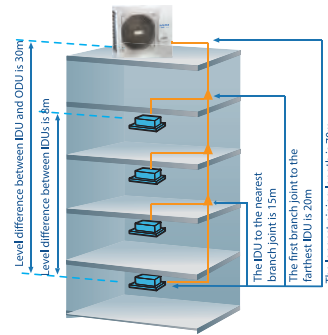

		Permitted value(m)	7.2/9.2/11kW	14.5/17kW
Piping length	Total piping length (Actual)		100m	100m
	Longest piping (L)	Actual length	45m	60m
		Equivalent length	50m	70m
Level difference	Equivalent piping length (from the farthest IDU to the first indoor branch joint)		20m	20m
	Level difference between IDU-ODU	Outdoor unit up	30m	30m
		Outdoor unit down	20m	20m
	Level difference between IDU-IDU		8m	8m

1 Total pipe length is equal to all the liquid pipe or all the gas pipe length.
2 When the total equivalent pipe length of liquid side plus gas side is more than 90m it needs to meet the specific conditions according to the installation part of the technical manual.

Specifications

Model name			VDVC-V72W/DN1	VDVC-V92W/DN1	VDVC-V110W/DN1	VDVC-V145W/DN1	VDVC-V170W/DN1
Power supply		V-Ph-Hz	1-phase, 220-240V, 50Hz				
Cooling ¹	Capacity	kW	7.2	9.2	11	14.5	17
	Power input	kW	1.64	2.13	2.75	3.57	4.24
	EER		4.39	4.32	4	4.06	4.01
Connected indoor units	Total capacity		45-130% of outdoor unit capacity				
	Maximum quantity		4	5	6	8	9
Compressor	Type		DC inverter				
	Quantity		1				
Fan motor	Motor Type		DC				
	Quantity		1				
Refrigerant	Type		R410A				
	Factory charging	kg	1.4	1.4	1.4	2.6	2.6
Pipe connections	Liquid pipe	mm	Φ9.53	Φ9.53	Φ9.53	Φ9.53	Φ9.53
	Gas pipe	mm	Φ15.9	Φ15.9	Φ15.9	Φ15.9	Φ15.9
Airflow rate		m ³ /h	3400	3400	3400	5100	5100
Sound pressure level ²		dB(A)	54	54	54	55	55
Net dimensions (W×H×D)		mm	973×862×302	973×862×302	973×862×302	1053×865×523	1053×865×523
Packed dimensions (W×H×D)		mm	1025×910×410	1025×910×410	1025×910×410	1120×890×560	1120×890×560
Net weight		kg	58	58	58	85	85
Gross weight		kg	63	63	63	92	92
Operating temperature range		°C	Cooling: -5 to 48				

Notes:
1. Indoor air temperature 27°C (80.6°F) DB, 19°C (66.2°F) WB; outdoor air temperature 35°C (95°F) DB; equivalent refrigerant piping length 7.5m (24.6ft.) with zero level difference.
2. Sound pressure level is measured at a position 1m (3.28ft.) in front of the unit and 1.3m (4.26ft.) above the floor in a semi-anechoic chamber.
3. For a system with more than one IDU, to ensure even distribution of refrigerant, the capacity of each indoor unit should not exceed 8kW.

SIDE DISCHARGE - Heat Pump

The capacity range of outdoor unit is from 20kW to 45kW with side air-discharge type. Maximum 15 indoor units with capacity up to 130% of total outdoor units can be connected in one refrigeration system.

7 HP / 8 HP / 10 HP



12 HP / 14 HP / 16 HP



Long Piping Length

		Permitted value	7/8/10 HP	12/14/16 HP
Total pipe length*(Actual)			120m	250m
Piping Length	Maximum piping(L)	Actual length	70m	120m
		Equivalent length	60m	100m
	Equivalent piping length from the farthest IDU to the first indoor branch joint		20m	40m
Level difference between IDU & ODU	Outdoor unit up		30m	30m
	Outdoor unit down		20m	20m
Level difference between IDU-IDU			8m	8m

*Total pipe length is equal to two times — pipe length.
When the total equivalent pipe length of liquid side plus gas side is more than 90m. It needs to meet the specific condition according to the installation part of the technical manual.

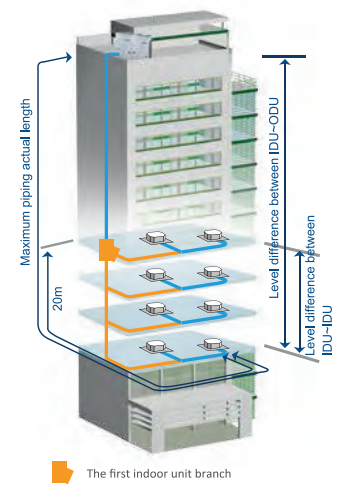

Specifications

Model			VDV-200W/DRN1	VDV-224W/DRN1	VDV-280W/DRN1	VDV-V335W/DRN1	VDV-V400W/DRN1	VDV-V450W/DRN1
Power supply		V/Ph/Hz	380~415/3/50	380~415/3/50	380~415/3/50	380~415/3/50	380~415/3/50	380~415/3/50
Capacity	Cooling	kW	20.0	22.4	28.0	33.5	40.0	45.0
	Heating	kW	22.0	24.5	28.5	35.0	45.0	50.0
Indoor unit connectable capacity range		%	50-130	50-130	50-130	50-130	50-130	50-130
Maximum connectable indoor units		nos.	10	11	12	13	14	15
Compressor	Type		Rotary	Rotary	Rotary	Rotary	Rotary	Rotary
	Quantity		01	01	01	01	02	02
Fan motor	Type		DC	DC	DC	DC+AC	DC+AC	DC+AC
	Quantity		01	01	02	02	02	02
Fan	Type		Axial	Axial	Axial	Axial	Axial	Axial
	Quantity		02	02	02	02	02	02
Airflow		CMH	10999	10464	10494	10837	16575	16575
Sound pressure level		dB(A)	59	59	60	62	62	62
Unit Dimension	Net (W x H x D)	mm	1120×1558×528	1120×1558×528	1120×1558×528	1120×1558×528	1360×1650×540	1460×1650×540
	Gross (W x H x D)	mm	1270×1720×565	1270×1720×565	1270×1720×565	1270×1720×565	1450×1785×560	1550×1785×560
Weight	Net / Gross	kg	137/153	146.5/162.5	147/163	155/171	240/260	275/290
	Type		R410A	R410A	R410A	R410A	R410A	R410A
Refrigerant Line	Liquid	mm	Ø9.52	Ø9.52	Ø9.52	Ø12.7	Ø12.7	Ø12.7
	Gas	mm	Ø19.1	Ø19.1	Ø22.2	Ø22.2	Ø25.4	Ø25.4
Ambient condition range	Cooling	°C	-5 ~ 48	-5 ~ 48	-5 ~ 48	-5 ~ 50	-5 ~ 50	-5 ~ 50
	Heating	°C	-15 ~ 24	-15 ~ 24	-15 ~ 24	-15 ~ 24	-15 ~ 24	-15 ~ 24

Notes:
The capacity is based on the following conditions:
Cooling: indoor temperature 27°C DB/19°C WB; outdoor temperature 35°C DB.
Heating: indoor temperature 20°C DB/15°C WB; outdoor temperature 7°C DB.
Refrigerant piping length 7.5 m at the height difference of 0 m.
DB - dry bulb, WB - wet bulb
Sound pressure level measured in a reverberation chamber in a distance of 1 m from the unit front. Microphone is placed 1.3 m above the floor.
Main pipelines diameters are provided for the calculated conditions and assuming 100% oversizing of the outdoor unit. Actual diameters should be determined on the basis of the data included in the technical documentation or with use of the selection software.

Product design and innovation are a continuous process in VOLTAS and hence the above specifications are subject to change without notice

INDOOR UNITS

One Way Cassette Unit



- Auto Restart
- Fresh Air
- Auto Addressing
- Follow Me
- Anti Cold-Air Function
- Cleanable Filter
- In-Built Drain Pump
- LED Display
- Super High Air Flow

Model	VDV-D18Q1/N1-D	VDV-D22Q1/N1-D	VDV-D28Q1/N1-D	VDV-D36Q1/N1-D	VDV-D45Q1/N1-C	VDV-D56Q1/N1-C	VDV-D71Q1/N1-C
Cooling capacity	kW	1.8	2.2	2.8	3.6	4.5	5.6
Heating capacity	kW	2.2	2.6	3.2	4.0	5.0	6.3
Power Input	W	41	41	41	41	80	85
Rated airflow (H/M/L)	CMH	523/404/275	523/404/275	573/456/315	573/456/315	704/630/503	860/810/702
Sound level (H/M/L)	dB(A)	37/34/30	38/34/30	39/37/34	40/38/34	41/39/35	42/40/36
Dimension	Unit	1054x169x425	1054x169x425	1054x169x425	1054x169x425	1147x200x640	1147x200x640
(WxHxD)	Panel	mm	1180x25x465	1180x25x465	1180x25x465	1425x10x755	1425x10x755
Weight - Unit/Panel	kg	12.5/3.5	12.5/3.5	13.0/3.5	13.0/3.5	31.5/9.0	31.5/9.0
Remote controller		Wireless remote controller RM05					

Two Way Cassette Unit



- Auto Restart
- Fresh Air
- Auto Addressing
- Follow Me
- Anti Cold-Air Function
- Cleanable Filter
- In-Built Drain Pump
- LED Display
- Super High Air Flow

Model	VDV-D22Q2/N1	VDV-D28Q2/N1	VDV-D36Q2/N1	VDV-D45Q2/N1	VDV-D56Q2/N1	VDV-D71Q2/N1
Cooling capacity	kW	2.2	2.8	3.6	4.5	5.6
Heating capacity	kW	2.6	3.2	4.0	5.0	6.3
Power Input	W	57	57	60	92	108
Rated airflow (H/M/L)	CMH	654/530/410	654/530/410	725/591/458	850/670/550	980/800/670
Sound level (H/M/L)	dB(A)	33/29/24	36/32/29	36/32/29	39/35/30	39/35/30
Dimension	Unit	1172x299x591	1172x299x591	1172x299x591	1172x299x591	1172x299x591
(WxHxD)	Panel	mm	1430x53x680	1430x53x680	1430x53x680	1430x53x680
Weight - Unit/Panel	kg	34.0/10.5	34.0/10.5	34.0/10.5	36.0/10.5	36.0/10.5
Remote controller		Wireless remote controller RM05				

Four Way Compact Cassette Unit



- Auto Restart
- Fresh Air
- Auto Addressing
- Follow Me
- Anti Cold-Air Function
- Cleanable Filter
- In-Built Drain Pump
- LED Display
- Super High Air Flow

Model	VDV-D22Q4/N1-A3	VDV-D28Q4/N1-A3	VDV-D36Q4/N1-A3	VDV-D45Q4/N1-A3
Cooling capacity	kW	2.2	2.8	3.6
Heating capacity	kW	2.6	3.2	4.0
Power Input	W	50	50	56
Rated airflow (H/M/L)	CMH	522/414/312	522/414/312	610/521/409
Sound level (H/M/L)	dB(A)	36/33/23	36/33/23	42/36/29
Dimension	Unit	570x260x570	570x260x570	570x260x570
(WxHxD)	Panel	mm	647x50x647	647x50x647
Weight - Unit/Panel	kg	16.0/2.4	16.0/2.4	16.0/2.4
Remote controller		Wireless remote controller RM05		

Note:
Cooling: Indoor temperature 27°C DB/19°C WB; Outdoor temperature 35°C DB/24°C WB
Heating: Indoor temperature 20°C DB/15°C WB; Outdoor temperature 7°C DB/6°C WB
Refrigerant piping length measured for the liquid side is 8m & Height difference is 0m.
DB - dry bulb, WB - wet bulb

INDOOR UNITS

Four Way Standard Cassette Unit



- Auto Restart
- Fresh Air
- Auto Addressing
- Follow Me
- Anti Cold-Air Function
- Cleanable Filter
- In-Built Drain Pump
- LED Display
- Super High Air Flow

Model	VDV-D56Q4/N1-D	VDV-D71Q4/N1-D	VDV-D80Q4/N1-D	VDV-D90Q4/N1-D	VDV-D100Q4/N1-D	VDV-D112Q4/N1-D	VDV-D140Q4/N1-D
Cooling capacity	kW	5.6	7.1	8.0	9.0	10.0	11.2
Heating capacity	kW	6.3	8.0	9.0	10.0	11.1	12.05
Power Input	W	75	82	97	160	160	170
Rated airflow (H/M/L)	CMH	1121/864/755	1385/1157/955	1431/1236/973	1758/1540/1300	1758/1540/1300	1758/1540/1300
Sound level (H/M/L)	dB(A)	42/38/35	45/42/39	45/42/39	48/45/43	48/45/43	48/45/43
Dimension	Unit	mm	904x230x840	904x230x840	904x230x840	904x300x840	904x300x840
(WxHxD)	Panel	mm	950x55x950	950x55x950	950x55x950	950x55x950	950x55x950
Weight - Unit/Panel	kg	26.0/6.0	26.0/6.0	26.0/6.0	32.0/6.0	32.0/6.0	32.0/6.0
Remote controller		Wireless remote controller RM05					

Wall Mounted Unit - M Series



- Auto Restart
- Auto Addressing
- Anti Cold-Air Function
- Cleanable Panel
- Follow Me
- LED Display

Model	VDV-22G/DHN1-M	VDV-28G/DHN1-M	VDV-36G/DHN1-M	VDV-45G/DHN1-M	VDV-56G/DHN1-M	VDV-71G/DHN1-M	VDV-80G/DHN1-M	VDV-90G/DHN1-M
Cooling capacity	kW	2.2	2.8	3.6	4.5	5.6	8.0	9.0
Heating capacity	kW	2.4	3.2	4.0	5.0	6.3	9.0	10.0
Power Input	W	8	9	19	19	27	49	82
Rated airflow (H/M/L)	CMH	422/393/356	417/370/316	656/573/488	594/507/424	747/648/547	1195/1005/809	1195/1005/809
Sound level (H/M/L)	dB(A)	31/30/29	31/30/29	33/32/30	35/33/31	38/36/34	44/39/36	44/39/36
Unit Dimension	mm	835x280x203	835x280x203	990x315x223	990x315x223	990x315x223	1194x343x262	1194x343x262
Unit Weight	kg	8.4	9.5	11.4	12.8	12.8	17.0	17.0
Remote controller		Wireless remote controller RM-05						

Wall Mounted Unit - R & S Series



- Auto Restart
- Auto Addressing
- Anti Cold-Air Function
- Cleanable Panel
- Follow Me
- LED Display

Model	VDV-D22G/N1-S	VDV-D28G/N1-S	VDV-D36G/N1-S	VDV-D45G/N1-S	VDV-D56G/N1-S	VDV-D71G-R3/N1Y	VDV-D80G-R3/N1Y	VDV-D90G-R3/N1Y
Cooling capacity	kW	2.2	2.8	3.6	4.5	5.6	7.1	8.0
Heating capacity	kW	2.4	3.2	4.0	5.0	6.3	8.0	10.0
Power Input	W	28	28	28	51	51	75	86
Rated airflow (H/M/L)	CMH	525/480/430	525/480/430	590/520/480	860/755/630	925/860/755	1190/780/580	1320/840/640
Sound level (H/M/L)	dB(A)	35/32/29	35/32/29	35/32/29	40/38/34	40/38/34	47/43/42	48/43/38
Unit Dimension	mm	915x290x230	915x290x230	915x290x230	1072x315x230	1072x315x230	1250x325x245	1250x325x245
Unit Weight	kg	13.0	13.0	13.0	15.1	15.1	20.0	20.0
Remote controller		Wireless remote controller RM-05						

Note:
Cooling: Indoor temperature 27°C DB/19°C WB; Outdoor temperature 35°C DB/24°C WB
Heating: Indoor temperature 20°C DB/15°C WB; Outdoor temperature 7°C DB/6°C WB
Refrigerant piping length measured for the liquid side is 8m & Height difference is 0m.
DB - dry bulb, WB - wet bulb

INDOOR UNITS

Medium Static Pressure Ductable Unit

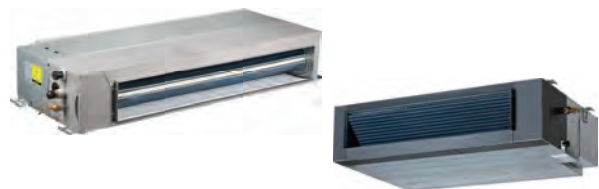

- Auto Restart
- Connectable To Duct
- Auto Addressing
- Follow Me
- Anti Cold-Air Function
- Wired Controller
- In-Built Drain Pump
- Super High Air Flow

Model		VDV-D22T2/N1-DA5	VDV-D28T2/N1-DA5	VDV-D36T2/N1-DA5	VDV-D45T2/N1-DA5	VDV-D56T2/N1-DA5
Cooling capacity	kW	2.2	2.8	3.6	4.5	5.6
Heating capacity	kW	2.6	3.2	4.0	5.6	6.3
Power Input	W	57	57	61	98	103
Rated airflow (H/M/L)	CMH	540/456/378	540/456/378	600/516/432	810/684/576	810/684/576
Sound level (H/M/L)	dB(A)	36/35/32	37/35/32	39/38/34	39/38/34	39/38/34
Unit Dimension	mm	740×210×500	740×210×500	740×210×500	960×210×500	960×210×500
ESP	Pa	10(10-30)	10(10-30)	10(10-30)	10(10-30)	10(10-30)
Unit Weight	kg	17.5	17.5	17.5	22.5	22.5
Remote controller		Wired remote controller KJR-12B				

Model		VDV-D71T2/N1-DA5	VDV-D80T2/N1-BA5	VDV-D90T2/N1-BA5	VDV-D112T2/N1-BA5	VDV-D140T2/N1-BA5
Cooling capacity	kW	7.1	8.0	9.0	11.2	14.0
Heating capacity	kW	8.0	9.0	10.0	12.5	16.0
Power Input	W	140	198	200	213	274
Rated airflow (H/M/L)	CMH	1032/936/780	1224/1020/864	1224/1020/864	1782/1548/1350	1950/1602/1398
Sound level (H/M/L)	dB(A)	41/39/35	47/41/37	45/40/37	47/41/37	47/42/38
Unit Dimension	mm	1180×210×500	1230×270×710	1230×270×710	1230×270×775	1290×300×865
ESP	Pa	10(10-30)	20(10-50)	20(10-50)	40(10-80)	40(10-100)
Unit Weight	kg	28.0	38.0	40.0	40.0	49.0/58.0
Remote controller		Wired remote controller KJR-12B				

High Static Pressure Ductable Unit



- Auto Restart
- Connectable To Duct
- Auto Addressing
- Follow Me
- Anti Cold-Air Function
- Wired Controller

Model		VDV-D71T1/N1-B	VDV-D80T1/N1-B	VDV-D90T1/N1-B	VDV-D112T1/N1-B	VDV-D140T1/N1-B	VDV-D160T1/N1-B
Cooling capacity	kW	7.1	8.0	9.0	11.2	14.0	16.0
Heating capacity	kW	8.0	9.0	10.0	12.5	16.0	17.0
Power Input	W	263	263	423	524	724	940
Rated airflow (H/M/L)	CMH	1443/1361/1218	1443/1338/1220	1951/1741/1518	2116/1936/1520	3000/2618/2226	3620/3044/2744
Sound level (H/M/L)	dB(A)	48/46/44	48/46/44	52/49/47	52/49/47	53/50/48	54/52/50
Unit Dimension	mm	952×420×690	952×420×690	952×420×690	952×420×690	1300×420×691	1300×420×691
ESP	Pa	25(25-196)	37(37-196)	37(37-196)	50(50-196)	50(50-196)	50(50-196)
Unit Weight	kg	45.0	45.0	46.5	50.6	68.0	70.0
Remote controller		Wired remote controller KJR-29B					

Model		ACDEU55CZGR410V	VDV-D200T1/N1-B	VDV-D250T1/N1-B	ACDEU85CZGR410V	VDV-D280T1/N1-B	ACDEU110CZGR410V
Cooling capacity	kW	19.3	20.0	25.0	28.0	28.0	39.0
Heating capacity	kW	21.5	22.5	26.0	31.5	31.5	43.0
Power Input	W	900	1516	1516	1250	1516	1700
Rated airflow (H/M/L)	CMH	3740/3553/3366	4700/4100/3599	4700/4100/3599	4000/3200/2600	4700/4100/3599	7480/7106/6732
Sound level (H/M/L)	dB(A)	51/49/48	59/57/52	59/57/52	52/50/49	59/57/52	53/51/49
Unit Dimension	mm	1228×665×404	1443×470×810	1443×470×810	1350×700×460	1443×470×810	1820×780×475
ESP	Pa	196	200(50-280)	200	200	200(50-280)	280
Unit Weight	kg	65	115.0	115.0	91	115.0	110
Remote controller		Wired remote controller KJR-29B					

Model		VDV-D400T1/N1	VDV-D450T1/N1	VDV-D560T1/N1	ACDEU170CZGR410V
Cooling capacity	kW	40.0	45.0	56.0	56.0
Heating capacity	kW	45.0	50.0	63.0	61.5
Power Input	W	2700	2700	3400	2500
Rated airflow (H/M/L)	CMH	7476/6072/4995	7476/6072/4995	9550/7950/6600	11220/10659/10098
Sound level (H/M/L)	dB(A)	61/59/56	61/59/56	63/60/57	53/51/49
Unit Dimension	mm	1970×668×903	1970×668×903	1970×668×903	2150×825×520
ESP	Pa	200(50-280)	200(50-280)	200(50-280)	280
Unit Weight	kg	232.0	232.0	235.0	180
Remote controller		Wired remote controller KJR-29B			

Note:
Cooling: Indoor temperature 27°C DB/19°C WB; Outdoor temperature 35°C DB/24°C WB
Heating: Indoor temperature 20°C DB/15°C WB; Outdoor temperature 7°C DB/6°C WB
Refrigerant piping length measured for the liquid side is 8m & Height difference is 0m.
DB - dry bulb, WB - wet bulb

INDOOR UNITS

Floor Standing Units



- Auto Restart
- LED Display
- Auto Addressing
- Follow Me
- Anti Cold-Air Function
- Cleanable Filter

Model		VDV-D22Z/N1-F3B	VDV-D28Z/N1-F3B	VDV-D36Z/N1-F3B	VDV-D45Z/N1-F3B	VDV-D56Z/N1-F3B	VDV-D71Z/N1-F3B	VDV-D80Z/N1-F3B
Cooling capacity	kW	2.2	2.8	3.6	4.5	5.6	7.1	8.0
Heating capacity	kW	2.4	3.2	4.0	5.0	6.3	8.0	9.0
Power Input	W	40	46	46	49	88	130	130
Rated airflow (H/M/L)	CMH	530/456/400	570/485/420	624/522/375	660/540/440	1150/970/830	1380/1100/870	1380/1100/870
Sound level (H/M/L)	dB(A)	36/33/29	36/33/29	37/34/30	37/34/30	41/35/31	44/39/33	44/39/33
Unit Dimension	mm	840×545×212	840×545×212	1040×545×212	1040×545×212	1440×545×212	1440×545×212	1440×545×212
Unit Weight	kg	25.0	25.0	27.0	27.0	33.0	33.0	33.0
Remote controller		Wireless remote controller RM-05						

Ceiling and Floor Units



- Auto Restart
- LED Display
- Auto Addressing
- Follow Me
- Anti Cold-Air Function
- Cleanable Panel

Model		VDV-D36DL/N1-C	VDV-D45DL/N1-C	VDV-D56DL/N1-C	VDV-D71DL/N1-C	VDV-D80DL/N1-C
Cooling capacity	kW	3.6	4.5	5.6	7.1	8.0
Heating capacity	kW	4.0	5.0	6.3	8.0	9.0
Power Input	W	49	120	122	125	130
Rated airflow (H/M/L)	CMH	650/570/500	800/600/500	800/600/500	800/600/500	1200/900/700
Sound level (H/M/L)	dB(A)	40/38/36	43/41/38	43/41/38	43/41/38	45/43/40
Unit Dimension	mm	990×203×660	990×203×660	990×203×660	990×203×660	1280×203×660
Unit Weight	kg	26.0	28.0	28.0	28.0	34.5
Remote controller		Wireless remote controller RM-05				

Model		VDV-D90DL/N1-C	VDV-D112DL/N1-C	VDV-D140DL/N1-C	VDV-D160DL/N1-C
Cooling capacity	kW	9.0	11.2	14.0	16.0
Heating capacity	kW	10.0	12.5	15.0	18.0
Power Input	W	130	182	182	300
Rated airflow (H/M/L)	CMH	1200/900/702	1980/1860/1730	1980/1860/1730	1980/1860/1730
Sound level (H/M/L)	dB(A)	45/43/40	47/45/42	47/45/42	47/45/42
Unit Dimension	mm	1280×203×660	1670×244×680	1670×244×680	1670×285×680
Unit Weight	kg	34.5	54.0	54.0	57.5
Remote controller		Wireless remote controller RM-05			

Fresh Air Processing Unit



- Auto Restart
- Connectable To Duct
- Auto Addressing
- Follow Me
- Anti Cold-Air Function
- Wired Controller

Model		VDV-D125T1/N1-FA	VDV-D140T1/N1-FA	VDV-D200T1/N1-FA	VDV-D250T1/N1-FA	VDV-D280T1/N1-FA
Cooling capacity	kW	12.5	14.0	20.0	25.0	28.0
Heating capacity	kW	10.5	12.0	18.0	20.0	22.0
Power Input	W	430	430	1063	1063	1063
Rated airflow (H/M/L)	CMH	2142/1870/1611	2142/1870/1611	2870/2620/2150	3005/2700/2250	3005/2700/2250
ESP	Pa	50(50-196)	50(50-196)	200(50-280)	200(50-280)	200(50-280)
Sound level (H/M/L)	dB(A)	54/52/20	54/52/50	54/53/51	55/54/52	55/54/52
Unit Dimension	mm	1300×420×690	1300×420×690	1443×470×810	1443×470×810	1443×470×810
Unit Weight	kg	69.5	69.5	115.0	115.0	115.0
Remote controller		Wired remote controller KJR-29B				

Note:
Cooling: Indoor temperature 27°C DB/19°C WB; Outdoor temperature 35°C DB/24°C WB
Heating: Indoor temperature 20°C DB/15°C WB; Outdoor temperature 7°C DB/6°C WB
Refrigerant piping length measured for the liquid side is 8m & Height difference is 0m.
DB - dry bulb, WB - wet bulb

VENTILATION SYSTEMS

Heat Recovery Ventilation Unit

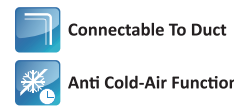

Model	HRV-200	HRV-300	HRV-400	HRV-500	HRV-800	HRV-1000	HRV-1500	HRV-2000
Power Supply (V/Ph/Hz)	220-240/1/50	220-240/1/50	220-240/1/50	220-240/1/50	220-240/1/50	220-240/1/50	380-415/3/50	380-415/3/50
Cooling Exchange Eff. %	55-60	55-60	55-60	55-60	55-60	55-60	55	55
Heating Exchange Eff. %	60-65	60-65	60-65	60-65	60-65	60-65	65	65
Input Power W	20	40	80	120	360	360	450	450
Rated airflow (H/M/L) CMH	200/200/150	300/300/225	400/400/300	500/500/375	800/800/600	1000/1000/750	1500	2000
ESP (H/M/L) Pa	75/58/35	75/60/40	80/65/43	80/68/45	100/82/54	100/85/58	160	160
Sound level (Heat Ex.) dB(A)	27/26/20	30/29/23	32/31/25	35/34/28	39/38/32	40/39/33	51	51
Sound level (Bypass) dB(A)	28/27/22	31/30/25	33/32/27	36/35/27	40/39/34	41/40/35	52	54
Unit Dimension mm	866x655x264	944x722x270	944x927x270	1038x1026x270	1286x1006x388	1286x1256x388	1600x1270x540	1650x1470x540
Unit Weight kg	23.0	26.0	31.0	41.0	62	79	163	182
Remote controller	Wireless remote controller RM-05							

ACCESSORIES AND CONTROL SYSTEM

Touch Screen Centralised Controller (CCM-180A/WS & CCM-270A/WS)



CCM-180A/WS



CCM-270A/WS

- Upto 384 IDUs, 192 ODU's and 48 refrigerant systems under single controller.
- Touch screen- Smart and elegant controller for premium system.
- Electricity charge distribution – Billing calculation for different IDUs connected under same system.
- Energy Management - Set limits or locks on indoor units.
- Visual schematic of entire system.
- Group Management- Units can be viewed according to group, system or location for convenient controlling.
- Outdoor unit configuration and settings can be monitored and controlled.
- Schedule management - Daily, weekly and annual schedules.
- LAN Access and wiring flexibility.

ACCESSORIES AND CONTROL SYSTEM

Cordless Remote (RM 05)



- Easy to Read Display with Backlight
- Unit Address Setting
- Mode selection - Auto, Cool, Dry, Heat, Fan only
- Temperature setting range - 17°C to 30°C
- Daily Timer setting
- Louver AUTO-Swing
- Fan speed control - High/Medium/Low/Auto
- Economic operation button

Wired Remote

(KJR-12B)



- Easy to Read Display with Backlight
- Unit Address Setting
- Mode selection - Auto, Cool, Dry, Heat, Fan only
- Temperature setting - 17°C to 30°C

(KJR-29B)



- Daily Timer setting
- Louver AUTO-Swing
- Fan speed control - High/Medium/Low/Auto
- Economic operation button
- Follow me Function

Applicable Only For Side Discharge Units

Central Remote Controller for ODU (CCM02)



- Up to 8 systems, max.32 outdoor units can be monitored
- Display the operating parameter of outdoor units
- Display the error or protection code of outdoor units

Central Remote Controller for IDU (CCM03)



- Clear & bright LCD display screen with Backlight
- Controls & Monitor Individual or Group of Indoor Units
- Mode selection: Auto, Cool, Dry, Heat, Fan only
- Temperature setting range: 17° to 30°C
- Daily Timer setting
- Louver AUTO-Swing
- Fan speed control: High/Medium/Low/Auto
- Economic operation button
- Memory function: It can record the Indoor Unit parameters
- Emergency ON/OFF control with simple dry contact input

Central Remote Controller for IDU (CCM30)



- Touch-style key centralized controller
- Clear & bright LCD display screen with Backlight
- Controls & Monitor Individual or Group of Indoor Units
- Mode selection: Auto, Cool, Dry, Heat, Fan only
- Temperature setting range: 17° to 30°C
- Daily Timer setting
- Louver AUTO-Swing
- Fan speed control: High/Medium/Low/Auto
- Economic operation button
- Memory function: It can record the Indoor Unit parameters
- Emergency ON/OFF control with simple dry contact input

Central Remote Controller for IDU (CCM09)



- Weekly schedule timer centralized controller
- Clear & bright LCD display screen with Backlight
- Controls & Monitor Individual or Group of Indoor Units
- Mode selection: Auto, Cool, Dry, Heat, Fan only
- Temperature setting range: 17° to 30°C
- Daily Timer setting
- Louver AUTO-Swing
- Fan speed control: High/Medium/Low/Auto
- Economic operation button
- Memory function: It can record the Indoor Unit parameters
- Emergency ON/OFF control with simple dry contact input

ACCESSORIES AND CONTROL SYSTEM

Network Control system (IMMP-M)

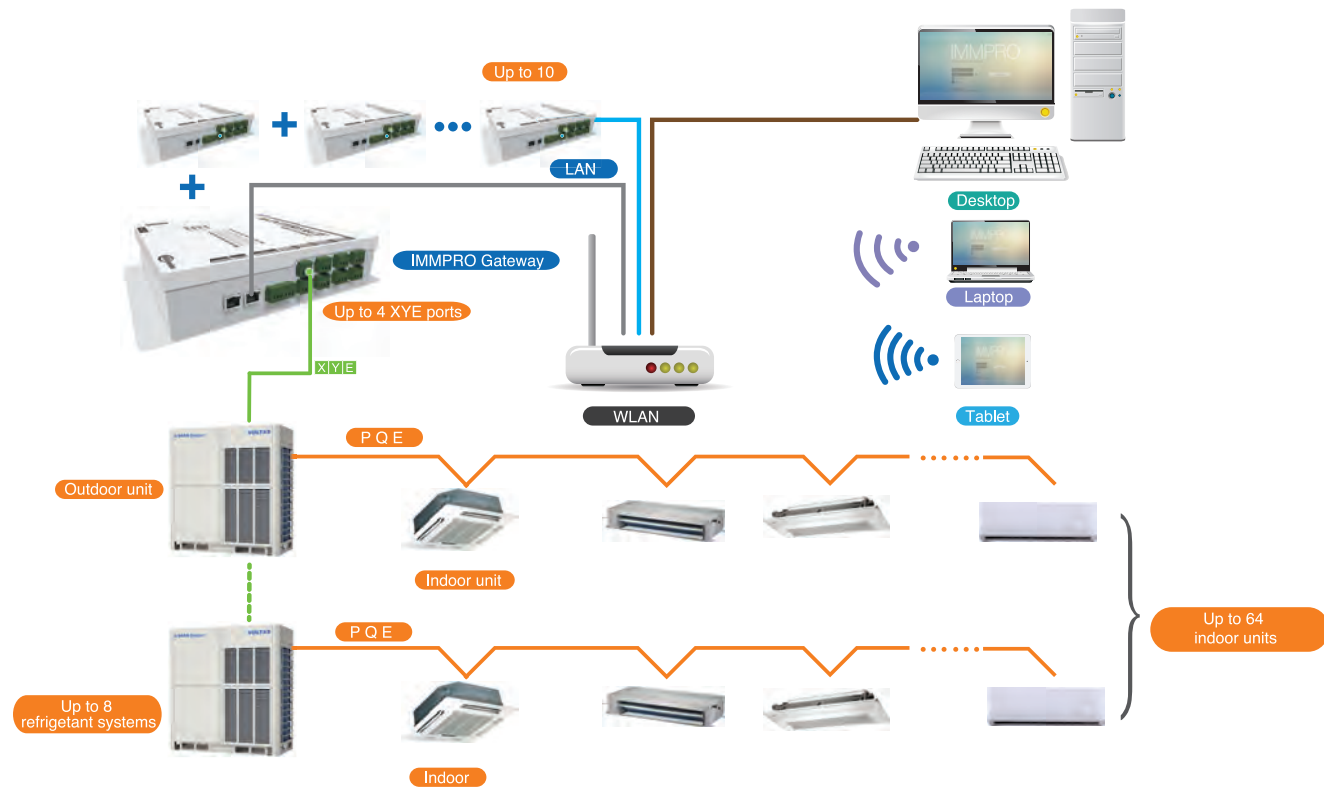

Network Control system (CCM-270A/WS)

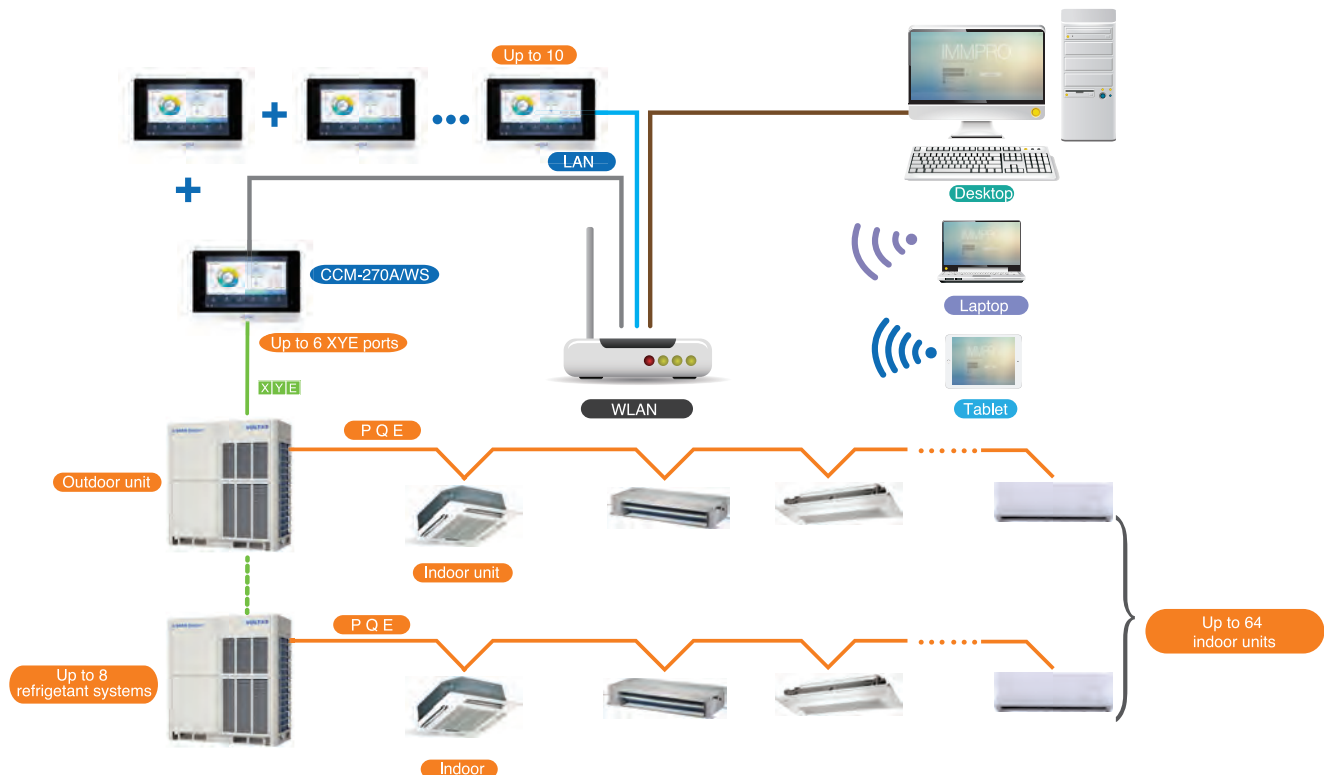

BMS GATEWAY

BMS Gateway Modbus



GW-MOD

- Supports MODBUS Protocol BMS networks
- TCP/IP or RTU
- Data transfer in RTU mode
- Max 64 IDUs, 4 ODUs and 1 refrigerant system can be controlled

BMS Gateway BACnet



GW-BAC

- Supports BACnet® Protocol BMS network
- Gateway connected to Master unit's X/Y/E ports directly
- Upto 256 devices (IDUs+ODUs) and 32 refrigerant systems can be controlled
- Web access through IMMP-BAC and BACnet® BMS access through GW-BAC

BACnet® is a registered trademark of ASHRAE

BMS Gateway LonWorks



GW-LON

- Supports LonWorks Protocol BMS network
- Max 64 IDUs, 34 ODUs and 8 refrigerant systems can be controlled

VRF AHU CONTROL BOX

Single AHU Control Box Connection

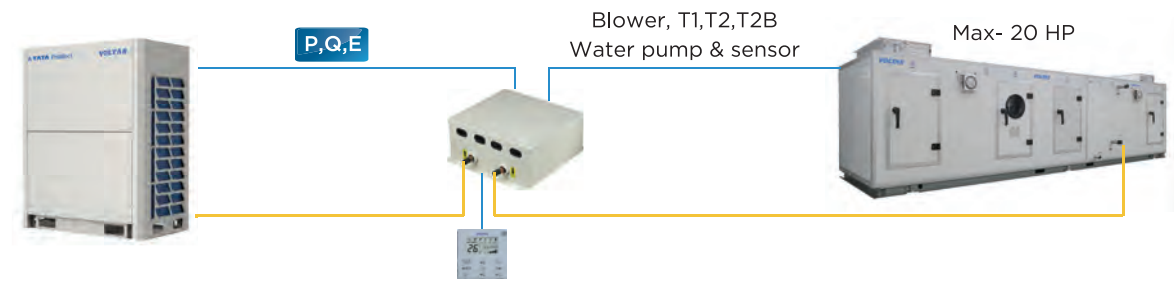

Multi AHU Control Boxes Connection

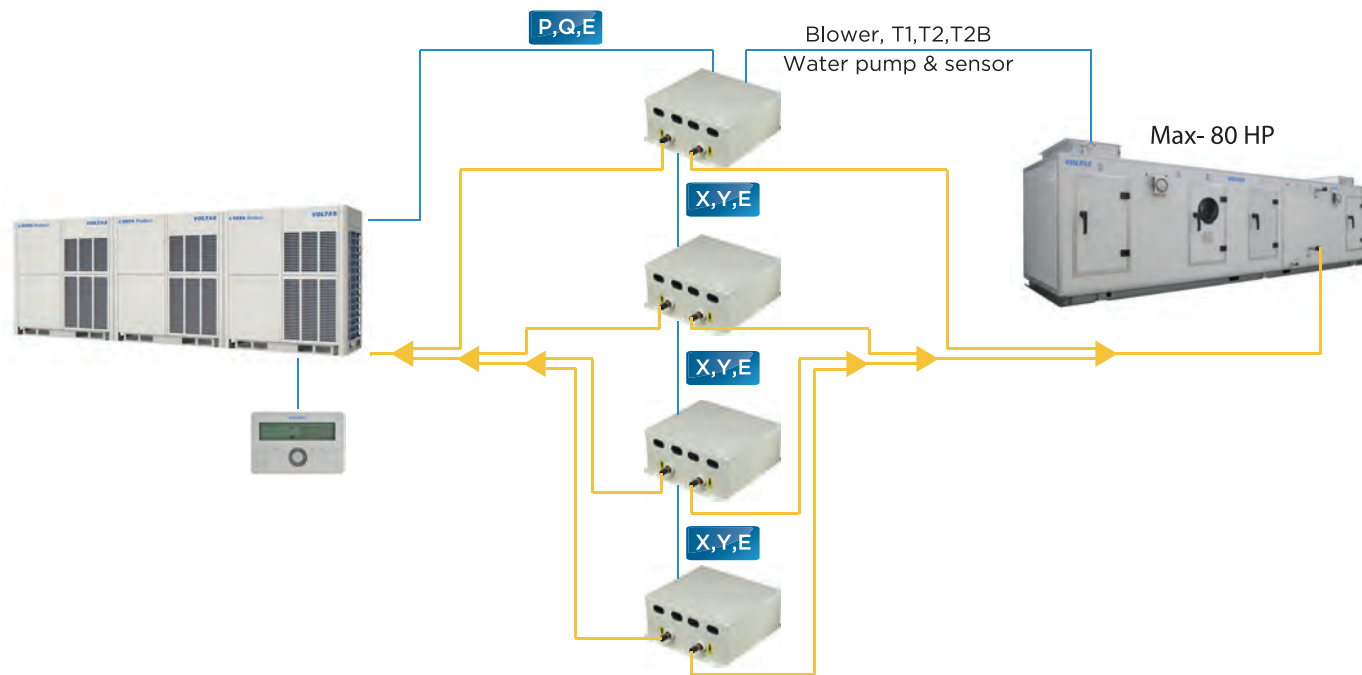

Specifications

Model		AHUKZ-01B	AHUKZ-02B	AHUKZ-03B
Capacity	HP	3.2-6	8-12	14-20
Power supply		1 phase, 208-230V, 60Hz		
Refrigerant			R410A	
Pipe connections (inlet and outlet)	mm	Φ8	Φ12.7	Φ15.9
Net dimensions (W×H×D)	mm	350×150×375		
Packed dimensions (W×H×D)	mm	420×240×490		
Net weight	kg	8.4	8.7	8.9
Gross weight	kg	11.4	11.7	11.9
Operating modes		Cooling, heating and fan only		
Standard controller		Wired controller		
Optional controller		Wireless remote controller; SIEMENS controller		

HOTEL KEY CARD INTERFACE MODULES

Full Integration

The Hotel Key Card Interface Modules enable power supply to indoor units to be integrated with hotel key card power supply management systems, which are designed to save energy by only running appliances whilst guests are present in their room.

Model	MD-NIM05/E	MD-NIM05B/E
Appearance		
Network flexibility		
Auto restart	●	●
Compatibility	Remote and wired controller	Remote and wired controller
Dimensions (H W D) (mm)	15.5 86 72.8	87 150 70
Power supply	5V DC (Supplied by indoor unit)	1 phase, 100-240V, 50/60Hz

Note: The Hotel Key Card Interface Modules only compatible while using the infrared communication ports of wired Controllers.

AWARDS & RECOGNITION

- 2018**
 - ★ Voltas "India's Most Trusted Air Conditioner Brand"
 - ★ Strategy Leaders Summit & Awards 2018.
 - ★ MEP Contractor and Plumbing Project of the Year award.
- 2017**
 - ★ *Indywood Built in India Excellence award*
 - ★ IGBC - 'Gold' rating for Voltas Limited Office at Coimbatore.
- 2016**
 - ★ *Winner of Eco Times' Best Corporate Brands 2016*
- 2015**
 - ★ *Dun & Bradstreet Corporate Awards*
 - ★ *Top Taxpayers' Award* Dept. of Central Excise & Service Tax
 - ★ *EFFIE Award (silver)* for Effectiveness in Advertising
- 2014**
 - ★ *Tata Group's Excellence in Communications Award*
 - ★ *World Advertising Research Centre Asia Awards Gold Prize*
 - ★ *National Energy Conservation Award*
Govt. of India Ministry of Power



Voltas was recognised as the 'Best Brand in Digital Marketing Excellence in Consumer Durables Category' at DigiXX 2018

Voltas Domestic Projects Group recognised at *Indywood Built in India Excellence Awards 2018*

2008 / 2010 / 2011 / 2012 / 2013

- ★ *MEP Middle East Awards*
- ★ *MEP Contractor of the Year*
- ★ *MEP Project Manager of the Year' and 'Health & Safety'*
- ★ *Silver LEED certification*
- ★ *Bry-Air Award for excellence in product Design for VAM*